

Overload relays

1

E Line thermal overload relay



xStart series overload relay



xStart C series overload relay



D Line thermal overload relay



1.1	E Line thermal overload relay	
	Thermal overload relays XTOD/XTOG	2
1.2	xStart series overload relays	
	Bimetal relay ZE, ZB, Z5	9
	Overload relay ZW7	9
	Electronic overload relays ZEB	11
	EMT6 thermistor overload relay for machine protection	11
	C441 Overload and monitoring relay	44
1.3	xStart C series overload relay	
	Thermal overload relay ZB..C	70
1.4	D Linethermal overload relay	
	Thermal overload relays XTOD	82



Powering Business Worldwide

Thermal overload relays XTOD/XTOG



Contents

Description

Page

Thermal overload relays XTOD/XTOG	
System overview	2
Product selection	3
Technical data	5
Dimensions	6

Thermal overload relays XTOD/XTOG

Product description

XTOD/XTOG thermal overload relays offer precision motor protection with phase loss protection and ambient temperature compensation. The separate mount design allows for flexibility and the units can be mounted on DIN rail or directly on the panel adjacent the motor contactor.

XTOD... is for separate mounting; XTOG is for direct mounting.

Features

- Precision motor protection up to 97A
- Integral 1NO/1NC contact for contactor control and alarm signal
- Phase loss protection
- Ambient temperature compensation
- DIN rail or panel mount options

System overview

Thermal overload relays provide protective features for 1 or 3 phase motors. The relay monitors the operating current of the motor and switched the contactor off in the event of an overload situation. It also protects the motor from damage during phase loss.

Standards and certifications

- GB 14048
- IEC/EN 60947
- CCC
- CE

1.1

Thermal overload relays XTOD/XTOG

Product selection

1

Thermal overload relays

XTOD..CC1S



For use with		Setting range of overload releases I_r (A)	Circuit symbol	Auxiliary contact	Part no. Article no.	Standard package
				N/O = Normally open N/C = Normally closed		
XTCG007	Seperate mounting	0.3~0.45		1 N/O 1 N/C	XTODP45CC1S 167952	1 piece
XTCG009	Seperate mounting	0.45 ~0.67		1 N/O 1 N/C	XTODP67CC1S 167953	1 piece
XTCG012						
XTCG018	Seperate mounting	0.67~1.0		1 N/O 1 N/C	XTOD001CC1S 167954	1 piece
XTCG025	Seperate mounting	1.0 ~1.5		1 N/O 1 N/C	XTOD1P5CC1S 167955	1 piece
XTCG032						
XTCG038	Seperate mounting	1.4 ~2.1		1 N/O 1 N/C	XTOD2P2CC1S 167956	1 piece
	Seperate mounting	1.8~2.7		1 N/O 1 N/C	XTOD2P7CC1S 167957	1 piece
	Seperate mounting	2.4~3.6		1 N/O 1 N/C	XTOD3P6CC1S 167958	1 piece
	Seperate mounting	3.5~5.0		1 N/O 1 N/C	XTOD005CC1S 167959	1 piece
	Seperate mounting	4.0~6.0		1 N/O 1 N/C	XTOD006CC1S 167960	1 piece
	Seperate mounting	5.5~8.5		1 N/O 1 N/C	XTOD8P5CC1S 167961	1 piece
	Seperate mounting	8.5~12.5		1 N/O 1 N/C	XTOD013CC1S 167962	1 piece
	Seperate mounting	12.5~18		1 N/O 1 N/C	XTOD018CC1S 167963	1 piece
	Seperate mounting	17~24		1 N/O 1 N/C	XTOD024CC1S 167964	1 piece
	Seperate mounting	22~30		1 N/O 1 N/C	XTOD030CC1S 167965	1 piece
XTOG...						
XTCG007	Direct mounting	0.1~0.16		1 N/O 1 N/C	XTOGP16BC1 173679	1 piece
XTCG009	Direct mounting	0.16~0.24		1 N/O 1 N/C	XTOGP24BC1 173680	1 piece
XTCG012						
XTCG018	Direct mounting	0.24~0.4		1 N/O 1 N/C	XTOGP40BC1 173681	1 piece
XTCG025	Direct mounting	0.4~0.6		1 N/O 1 N/C	XTOGP60BC1 173682	1 piece
XTCG032						
XTCG038	Direct mounting	0.6~1		1 N/O 1 N/C	XTOG001BC1 173683	1 piece
	Direct mounting	1~1.6		1 N/O 1 N/C	XTOG1P6BC1 173684	1 piece
	Direct mounting	1.6~2.4		1 N/O 1 N/C	XTOG2P4BC1 173685	1 piece
	Direct mounting	2.4~4		1 N/O 1 N/C	XTOG004BC1 173686	1 piece
	Direct mounting	4~6		1 N/O 1 N/C	XTOG006BC1 173687	1 piece
	Direct mounting	6~10		1 N/O 1 N/C	XTOG010BC1 173688	1 piece
	Direct mounting	9~12		1 N/O 1 N/C	XTOG012BC1 173689	1 piece
	Direct mounting	12~16		1 N/O 1 N/C	XTOG016CC1 173690	1 piece
	Direct mounting	16~24		1 N/O 1 N/C	XTOG024CC1 173691	1 piece
	Direct mounting	24~32		1 N/O 1 N/C	XTOG032CC1 173692	1 piece

Thermal overload relays XTOD/XTOG

Product selection

1.1

1

Thermal overload relays

For use with		Setting range of overload releases I_r (A)	Circuit symbol	Auxiliary contact	Part no. Article no.	Standard package
XTOG... 	XTCG040	Direct mounting	17-25	1 N/O 1 N/C	XTOG025DC1 173693	1 piece
	XTCG050	Direct mounting	23-32	1 N/O 1 N/C	XTOG032DC1 173694	1 piece
	XTCG065	Direct mounting	30-40	1 N/O 1 N/C	XTOG040DC1 173695	1 piece
	XTCG080	Direct mounting	37-50	1 N/O 1 N/C	XTOG050DC1 173696	1 piece
	XTCG095	Direct mounting	48-65	1 N/O 1 N/C	XTOG065DC1 173697	1 piece
		Direct mounting	37-50	1 N/O 1 N/C	XTOG050EC1 173698	1 piece
		Direct mounting	48-65	1 N/O 1 N/C	XTOG065EC1 173699	1 piece
		Direct mounting	63-80	1 N/O 1 N/C	XTOG080EC1 173700	1 piece
		Direct mounting	77-97	1 N/O 1 N/C	XTOG097EC1 173701	1 piece



N/O =Normally open
N/C =Normally closed

1.1

Thermal overload relays XTOD/XTOG

Technical data

1

General

XTOD/XTOG

Standards	IEC/EN 60947, GB 14048		
Climatic Proofing	Damp heat, constant, to IEC60068-2-78 Damp heat, cyclic, to IEC60068-2-30		

Ambient temperature

Open	°C	-25~55	
Enclosed	°C	-25~40	
Temperature compensation	°C	-5~40	
Weight	kg	0.15	
Protection type	IP20		

Main contacts

XTOD/XTOG

Rated impulse withstand voltage	U_{imp}	VAC	6000
Overvoltage category/pollution degree	III/3		

Rated insulation voltage

AC	U_i	VAC	690
Rated operational voltage	U_e	VAC	690
Overload release setting range	A		0.1-97

Terminal capacity

Solid	mm ²	1 x (1-6) 2 x (1-6)	
Flexible with ferrule	mm ²	1 x (1-6) 2 x (1-6)	
Solid/stranded	AWG		
Terminal screw	M4		
Tightening torque	Nm	1.2	

Auxiliary and control circuits

XTOD/XTOG

Rated impulse withstand voltage	U_{imp}	V	6000
Overvoltage category/pollution degree	III/3		

Terminal capacity

Solid	mm ²	1 x (1-6) 2 x (1-6)	
Flexible with ferrule	mm ²	1 x (1-6) 2 x (1-6)	
Solid/stranded	AWG		
Terminal screw	M3.5		
Tightening torque	Nm	0.8	
Rated insulation voltage	U_i	VAC	690
Rated operational voltage	U_e	VAC	690
Conventional thermal current	I_{th}	A	10
Rated operational current			

AC-15

120V	I_e	A	6
220/240V	I_e	A	3
380V	I_e	A	1.9
480V	I_e	A	1.5
500V	I_e	A	1.4
600V	I_e	A	1.2

DC-13

125V	I_e	A	0.55
250V	I_e	A	0.27

Thermal overload relays XTOD/XTOG

Dimensions

1.1

1

Dimensions

Thermal overload relay + mounting adapter

XTOD..CC1S

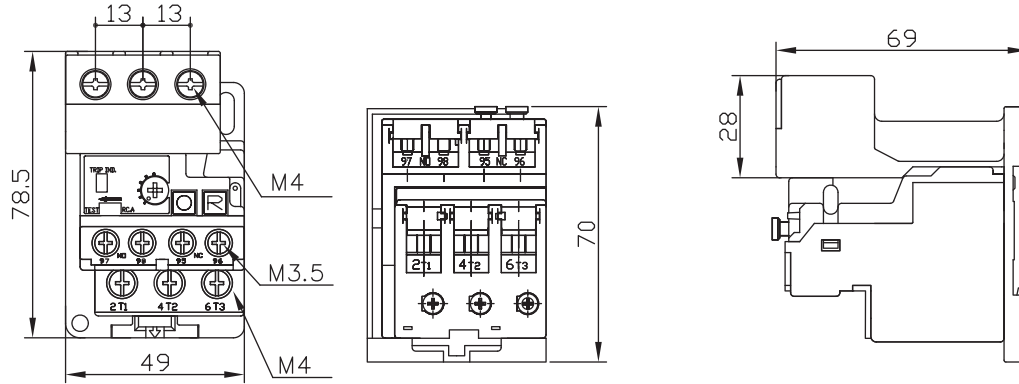

Thermal overload relays XTOG

17-65A

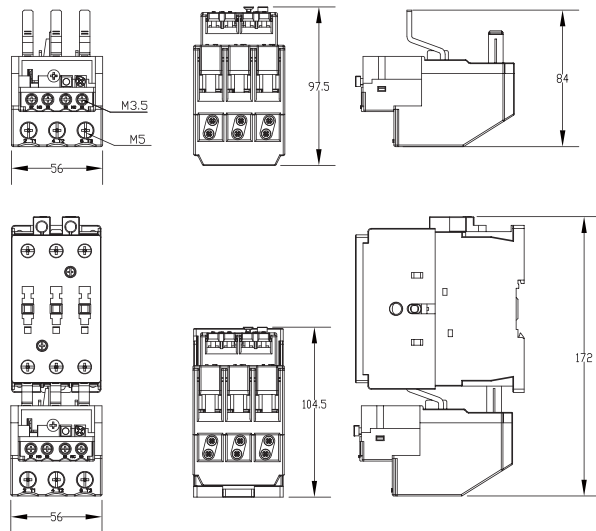

37-97A

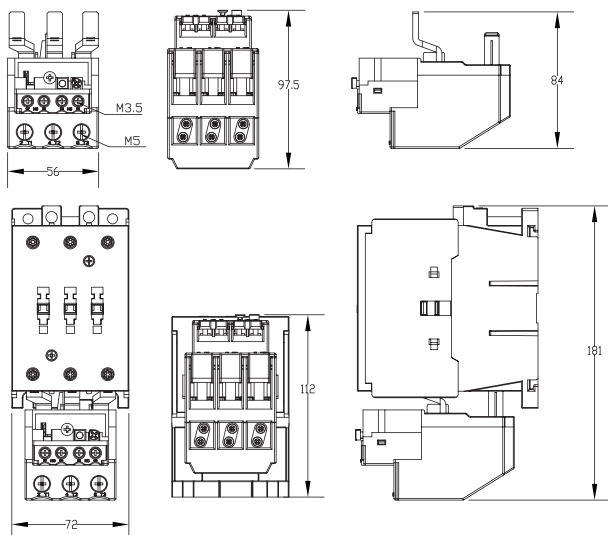

1.2 Overload relays

1



Overload relay

Motor protection is a central task of electrical equipment for machinery. From cost-effective bimetal solutions to demanding full motor protection with cross-linkage - we offer the right solution for each application.

ATEX 

Bimetal relay - overload relay up to 630 A

- Direct mounting on contactor saves mounting time.
- ATEX approval for the protection of EEx e motors up to 250 A.
- Comprehensive motor protection through phase failure sensitivity.
- Integrated test pushbutton facilitates high safety → Page 13.



ZEB electronic overload relay - overload relay up to 1500 A

- ATEX approval for protection of EEx e motors up to 1500 A.
- Adjustable tripping classes.
- Phase failure and unbalance protection.
- Optional earth fault detection.
- Additional current setting range (5:1) → Page 21.

EMT6 thermistor overload relay for machine protection

- Overload protection through direct evaluation of winding temperature.
- Quick detection of operating state through LED display.
- Suitable for overload monitoring of motors in EEx e range.
- Wide range power supply reduces amount of types → Page 26.

Overload relay



Contents

<i>Description</i>	<i>Page</i>
Technical overview	
Bimetal relay ZE, ZB, Z5	9
Overload relay ZW7	9
Electronic overload relays ZEB	11
EMT6 thermistor overload relay for machine protection	11
Ordering	
Bimetal relays for mini-contactor relays	13
Bimetal relays up to 150A	15
Bimetal relay greater than 150 A	19
Overload relays	19
Bimetal relay accessories	28
ZEB Electronic overload relay	31
Ordering	
EMT6 thermistor overload relay for machine protection	26
Engineering	
EMT6 thermistor overload relay for machine protection	27
Selection criteria ZE, ZB, Z5, ZW7	30
Characteristic curve ZB, Z5, ZW7	30
UL/CSA short-circuit strength ZE, ZB, Z5	31
Technical data	
Bimetal relay for mini-contactor relays	32
Bimetal relays up to 150A	32
Overload relays greater than 150 A	33
Overload relays	33
ZEB electronic overload relay	35
EMT6 thermistor overload relay for machine protection	36
Dimensions	
Bimetal relays for mini-contactor relays	37
Bimetal relays up to 150A	37
Bimetal relays greater than 150 A	39
Overload relay	39
ZEB electronic overload relay	40
EMT6 thermistor overload relay for machine protection	42

1.2

Overload relays

Overload relays, CT-operated overload relays

1

Technical overview

Overload relays, CT-operated overload relays

Setting ranges (A)
(note max. current of the contactor)



DILEM

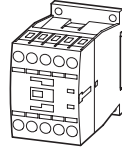

**DILM7 DILM12
DILM9 DILM15**

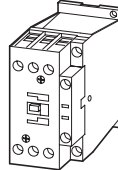

**DILM17 DILM32
DILM25 DILM38**

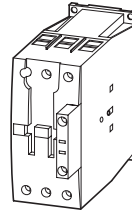

**DILM40 DILM65
DILM50 DILM72**

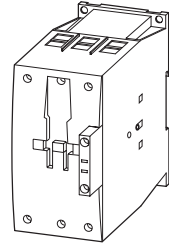

**DILM80 DILM150
DILM95 DILM170
DILM115**

Overload relays

ZE
0.1-12

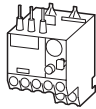

ZB12
0.1-16

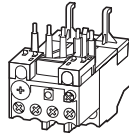

ZB32
0.1-38

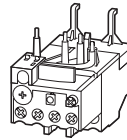

ZB65
6-75

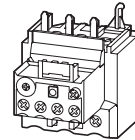

ZB150
35-175

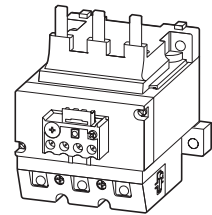

Z5-.../FF225A
70-250

Z5-.../FF250
50-300

Current transformer-operated overload relay

ZW7-...
42-630

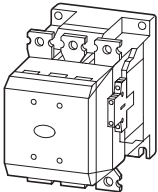

DILM185A
DILM225A

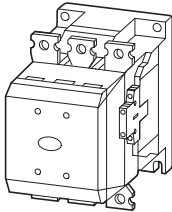

DILM250
DILM300

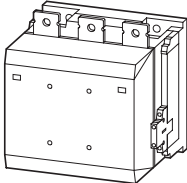

DILM400 DILM580
DILM500

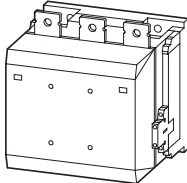

DILM650

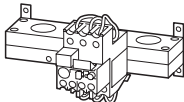
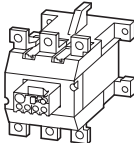
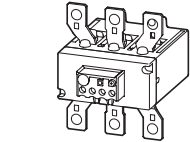

1.2

Overload relays

Electronic overload relays, thermistor overload relay for machine protection

1

Electronic overload relays, thermistor overload relay for machine protection

Setting ranges (A)
(note max. current of the contactor)



DILEM

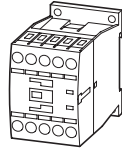

DILM7 DILM12
DILM9 DILM15

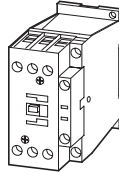

DILM17 DILM32
DILM25 DILM38

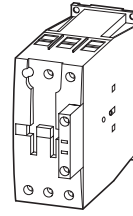

DILM40 DILM65
DILM50 DILM72

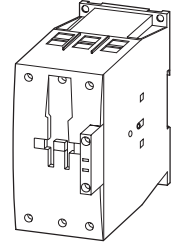

DILM80 DILM150
DILM95 DILM170
DILM115

Electronic overload relays

ZEB12
0.33-20

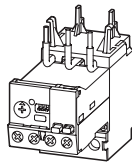

ZEB32
0.33-45

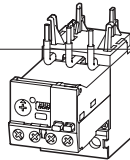

ZEB65
9-100

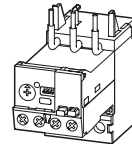

ZEB150
20-100

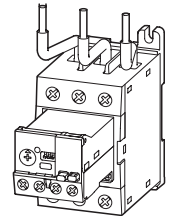

ZEB32-5-(GF)/KK combined with

ZEB-XCT300
60-300

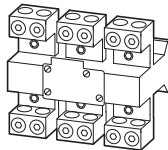

ZEB-XCT600
120-600

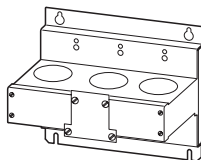

ZEB-XCT1000
200-1000

ZEB-XCT1500
300-1500

Thermistor overload relay for machine protection

EMT6((DB)K)

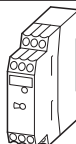

Overload relays

1.2

Electronic overload relays, thermistor overload relay for machine protection

1

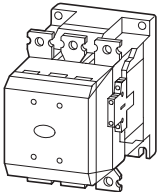

DILM185A
DILM225A

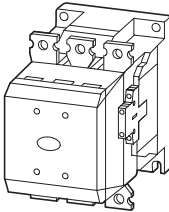

DILM250
DILM300

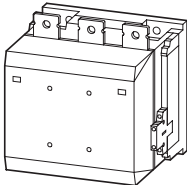

DILM400 **DILM580**
DILM500 **DILM650**

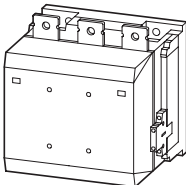

DILM750 **DILM820**

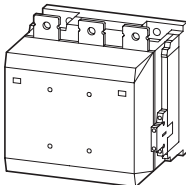

DILM1000

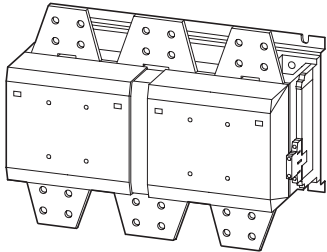

DILM1600

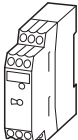

1.2

Overload relays

Bimetal relays for mini-contactor relays

1

Ordering

ZE overload relays for mini contactor relays

- Phase failure sensitivity to IEC/EN 60947, VDE 0660 Part 102
- Test/off pushbutton
- Reset pushbutton manual/auto
- Trip-free release
- Direct mounting

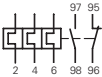
Setting range of overload releases	Circuit symbol	Auxiliary contact		For use with	Short-circuit protection	
		N/O = normally open contact NC = normally closed contact			Type "1" coordination gG/gL A	Type "2" coordination gG/gL A
I_r A 						
0.1 – 0.16		1 N/O	1 NC	DILEM DIULEM/21/MV SDAINLEM	20	0.5
0.16 – 0.24		1 N/O	1 NC		20	1
0.24 – 0.4		1 N/O	1 NC		20	2
0.4 – 0.6		1 N/O	1 NC		20	2
0.6 – 1		1 N/O	1 NC		20	4
1 – 1.6		1 N/O	1 NC		20	6
1.6 – 2.4		1 N/O	1 NC		20	6
2.4 – 4		1 N/O	1 NC		20	10
4 – 6		1 N/O	1 NC		20	10
6 – 9		1 N/O	1 NC		20	10
9 – 12		1 N/O	1 NC		20	10

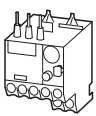

Information relevant for export to North America





Product Standards	UL 508; CSA-C22.2 No.14; IEC/EN 60947-4-1; CE marking
UL File No.	E29184
UL CCN	NKCR
CSA File No.	12528
CSA Class No.	3211-03
NA Certification	UL Listed, CSA certified
Suitable for	Branch circuits
Max. Voltage Rating	600 V AC
Degree of Protection	IEC: IP20, UL/CSA Type: -
See also	→ Page 31

Part no.
Article no.

Price
See price list

Std. pack

Notes

ZE-0.16 014263	1 Off 	Overload release: tripping class 10 A Short-circuit protection: With direct mounting, observe the maximum permissible fuse of the contactor.
ZE-0.24 014285		
ZE-0.4 014300		Suitable for protection of EEx e motors
ZE-0.6 014333		 II (2) GD PTB 01 ATEX 3331
ZE-1.0 014376		Observe manual AWB2300-1425D/GB.
ZE-1.6 014432		
ZE-2.4 014479		
ZE-4 014518		
ZE-6 014565		
ZE-9 014708		
ZE-12 014752		

With side-by-side mounting, there must be a minimum clearance of 5 mm between overload relays.

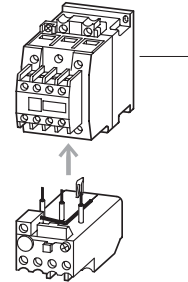

1 Contactor → Chapter 5
Accessories → Page 28
Manual → Page 28

1.2

Overload relays

Overload relays up to 150A

1

ZB12, ZB32

Setting range of overload releases

Circuit symbol

Auxiliary contact

For use with

Short-circuit protection



N/O = normally open contact
NC = normally closed contact

Contactors

Soft starters

Type "1" coordination
gG/gL

Type "2" coordination
gG/gL



ZB12 overload relay

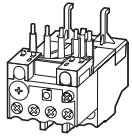

Setting range of overload releases	Circuit symbol	Auxiliary contact	For use with	Soft starters	Type "1" coordination gG/gL	Type "2" coordination gG/gL	
0.1 – 0.16		1 N/O 1 NC	DILM7, DILM9, DILM12, DILM15, DIULM7, DIULM9, DIULM12, SDAINLM12, SDAINLM16, SDAINLM22	–	25	0.5	
0.16 – 0.24		1 N/O 1 NC	–	–	25	1	
0.24 – 0.4		1 N/O 1 NC	–	–	25	2	
0.4 – 0.6		1 N/O 1 NC	–	–	25	4	
0.6 – 1		1 N/O 1 NC	–	–	25	4	
1 – 1.6		1 N/O 1 NC	–	–	25	6	
1.6 – 2.4		1 N/O 1 NC	–	–	25	10	
2.4 – 4		1 N/O 1 NC	–	–	DS7-34...SX004...	25	16
4 – 6		1 N/O 1 NC	–	–	DS7-34...SX005...	25	20
6 – 10		1 N/O 1 NC	–	–	DS7-34...SX007... DS7-34...SX009...	50	25
9 – 12	1 N/O 1 NC	–	–	DS7-34...SX012...	50	25	
12 – 16	1 N/O 1 NC	–	–	–	50	25	

ZB32 overload relay

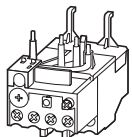

Setting range of overload releases	Circuit symbol	Auxiliary contact	For use with	Soft starters	Type "1" coordination gG/gL	Type "2" coordination gG/gL	
0.1 – 0.16		1 N/O 1 NC	DILM17, DILM25, DILM32, DILM38, DILMF8, DILMF11, DILMF14, DILMF17, DILMF25, DILMF32, DIULM17, DIULM25, DIULM32, SDAINLM30, SDAINLM45, SDAINLM55	–	25	0.5	
0.16 – 0.24		1 N/O 1 NC	–	–	25	1	
0.24 – 0.4		1 N/O 1 NC	–	–	25	2	
0.4 – 0.6		1 N/O 1 NC	–	–	25	4	
0.6 – 1		1 N/O 1 NC	–	–	25	4	
1 – 1.6		1 N/O 1 NC	–	–	25	6	
1.6 – 2.4		1 N/O 1 NC	–	–	25	10	
2.4 – 4		1 N/O 1 NC	–	–	25	16	
4 – 6		1 N/O 1 NC	–	–	25	20	
6 – 10		1 N/O 1 NC	–	–	50	25	
10 – 16		1 N/O 1 NC	–	–	DS7-34...SX016...	63	35
16 – 24		1 N/O 1 NC	–	–	DS7-34...SX024...	100	35
24 – 32		1 N/O 1 NC	–	–	DS7-34...SX032...	125	63
32 – 38		1 N/O 1 NC	–	–	–	125	63

Information relevant for export to North America



Product Standards

UL File No.
UL CCN
CSA File No.
CSA Class No.

UL 508; CSA-C22.2 No.14; IEC/EN 60947-4-1; CE marking
E29184
NKCR
12528
3211-03

NA Certification Suitable for
Max. Voltage Rating
Degree of Protection
See also





UL Listed, CSA certified
Branch circuits
600 V AC
IEC: IP20, UL/CSA Type: -
→ Page 31

Part no.
Article no.

Price
See price list

Std. pack

Notes

ZB12-0,16 278431		<p>1 Off</p> <p>Overload release: tripping class 10 A</p> <p>Short-circuit protection: With direct mounting, observe the maximum permissible fuse of the contactor.</p> <p>Suitable for protection of EEx e motors.</p> <p> II (2) GD</p> <p>PTB 04 ATEX 3022</p> <p>Observe manual AWB2300-1527D/GB.</p> <ul style="list-style-type: none"> Phase failure sensitivity to IEC/EN 60947, VDE 0660 Part 102 Test/off pushbutton Reset pushbutton manual/auto Trip-free release Direct mounting
ZB12-0,24 278432		
ZB12-0,4 278433		
ZB12-0,6 278434		
ZB12-1 278435		
ZB12-1,6 278436		
ZB12-2,4 278437		
ZB12-4 278438		
ZB12-6 278439		
ZB12-10 278440		
ZB12-12 278441		
ZB12-16 290168		
ZB32-0,16 278442		<p>1 Off</p> <p>Overload release: tripping class 10 A</p> <p>Short-circuit protection: With direct mounting, observe the maximum permissible fuse of the contactor.</p> <p>Suitable for protection of EEx e motors.</p> <p> II (2) GD</p> <p>PTB 04 ATEX 3022</p> <p>Observe manual AWB2300-1527D/GB.</p> <ul style="list-style-type: none"> Phase failure sensitivity to IEC/EN 60947, VDE 0660 Part 102 Test/off pushbutton Reset pushbutton manual/auto Trip-free release Direct mounting
ZB32-0,24 278443		
ZB32-0,4 278444		
ZB32-0,6 278445		
ZB32-1 278446		
ZB32-1,6 278447		
ZB32-2,4 278448		
ZB32-4 278449		
ZB32-6 278450		
ZB32-10 278451		
ZB32-16 278452		
ZB32-24 278453		
ZB32-32 278454		
ZB32-38 112474		

Fitted directly to the contactor

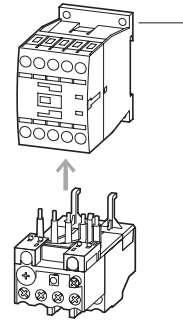

1 Contactor → Chapter 5
Accessories → Page 28
Manual → Page 28

Fitted directly to the contactor

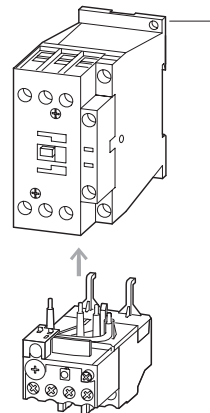

Separate mounting

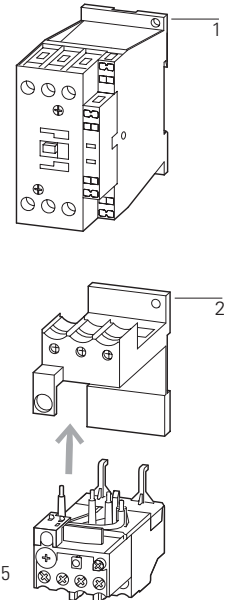

1 Contactor → Chapter 5
2 Base → Page 28
Manual → Page 28

1.2

Overload relays

Overload relays up to 150A

1

ZB65, ZB150

Setting range of overload releases

Circuit symbol

Auxiliary contact

For use with

Short-circuit protection

I_r

A



N/O = normally open contact
NC = normally closed contact

Type "1" coordination
gG/gL
A



Type "2" coordination
gG/gL
A



ZB65 overload relay

- Phase failure sensitivity to IEC/EN 60947, VDE 0660 Part 102
- Test/off pushbutton
- Reset pushbutton manual/auto
- Trip-free release
- Direct mounting

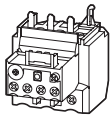

6 – 10

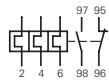

1 N/O 1 NC

DILM40, DILM50, DILM65,

50

25

10 – 16

1 N/O 1 NC

DILM72, DILMF40,

63

35

16 – 24

1 N/O 1 NC

DILMF50, DILMF65,

63

50

24 – 40

1 N/O 1 NC

DIULM40, DIULM50, DIULM65, SDAINLM70,

125

63

40 – 57

1 N/O 1 NC

SDAINLM90, SDAINLM115

160

80

50 – 65

1 N/O 1 NC

160

100

65 – 75

1 N/O 1 NC

250

160

ZB150 overload relay

- Phase failure sensitivity to IEC/EN 60947, VDE 0660 Part 102
- Test/off pushbutton
- Reset pushbutton manual/auto
- Trip-free release
- Direct mounting

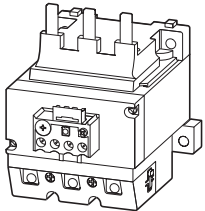

35 – 50



1 N/O 1 NC

DILM80, DILM95, DILM115, DILM150,

160

125

50 – 70

1 N/O 1 NC

DILM170, DILMF80,

250

160

70 – 100

1 N/O 1 NC

DILMF95, DILMF115,

315

200

95 – 125

1 N/O 1 NC

DILMF150, DIULM80, DIULM95,

315

250

120 – 150

1 N/O 1 NC

DIULM115, DIULM150, SDAINLM140,

315

250

145 – 175

1 N/O 1 NC

SDAINLM165, SDAINLM200, SDAINLM260

315

250

ZB150 overload relay

- Phase failure sensitivity to IEC/EN 60947, VDE 0660 Part 102
- Test/off pushbutton
- Reset pushbutton manual/auto
- Trip-free release
- Separate mounting

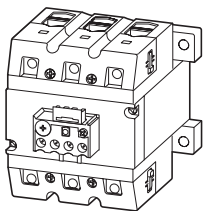

35 – 50

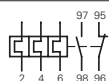

1 N/O 1 NC

DILM80, DILM95, DILM115, DILM150,

160

125

50 – 70

1 N/O 1 NC

DILM170, DILMF80,

250

160

70 – 100

1 N/O 1 NC

DILMF95, DILMF115,

315

200

95 – 125

1 N/O 1 NC

DILMF150, DIULM80, DIULM95,

315

250

120 – 150

1 N/O 1 NC

DIULM115, DIULM150, SDAINLM140,

315

250

145 – 175

1 N/O 1 NC

SDAINLM165, SDAINLM200, SDAINLM260

400

315

Information relevant for export to North America



Product Standards
UL File No.
UL CCN
CSA File No.
CSA Class No.
NA Certification
Suitable for
Max. Voltage Rating
Degree of Protection
See also





UL 508; CSA-C22.2 No.14; IEC/EN 60947-4-1; CE marking
E29184
NKCR
12528
3211-03
UL Listed, CSA certified
Branch circuits
600 V AC
IEC: IP00, UL/CSA Type: -
→ Page 31

Part no.
Article no.

Price
See price list

Std. pack

Notes



ZB65-10 278455	1 Off	Overload release: tripping class 10 A Short-circuit protection: With direct mounting, observe the maximum permissible fuse of the contactor.
ZB65-16 278456		
ZB65-24 278457		Suitable for protection of EExe motors.
ZB65-40 278458		 II (2) GD PTB 04 ATEX 3022
ZB65-57 278459		Observe manual AWB2300-1545D/GB.
ZB65-65 278460		
ZB65-75 108792		
ZB150-50 278462	1 Off	Overload release: tripping class 10 A Short-circuit protection: With direct mounting, observe the maximum permissible fuse of the contactor.
ZB150-70 278463		
ZB150-100 278464		Suitable for protection of EEx e motors.
ZB150-125 278465		 II (2) GD PTB 04 ATEX 3022
ZB150-150 278466		Observe manual AWB2300-1545D/GB.
ZB150-175 107316		

Fitted directly to the contactor

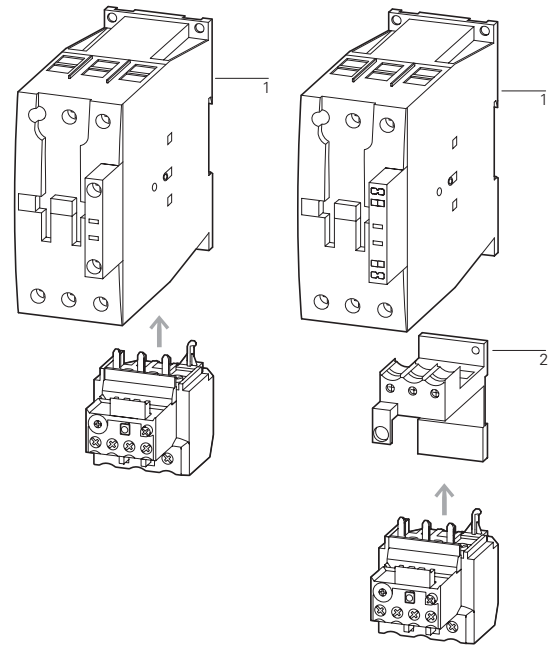
Separate mounting



1 Contactor → Chapter 5
2 Base → Page 28
Manual → Page 28

ZB150-50/KK 278468	1 Off	Overload release: tripping class 10 A Short-circuit protection: With direct mounting, observe the maximum permissible fuse of the contactor.
ZB150-70/KK 278469		
ZB150-100/KK 278470		Suitable for protection of EEx e motors.
ZB150-125/KK 278471		 II (2) GD PTB 04 ATEX 3022
ZB150-150/KK 278472		Observe manual AWB2300-1545D/GB.
ZB150-175/KK 107317		

1.2

Overload relays

Overload relays greater than 150 A, CT-operated overload relays

1

Z5, ZW7

Setting range of of overload releases

Circuit symbol

Auxiliary contacts

For use with

Short-circuit protection

N/O = normally open contact
NC = normally closed contact

Type "1"
coordination
gG/gL

Type "2"
coordination
gG/gL

I_r

A



A



A



Z5 overload relays greater than 150A

- Phase failure sensitivity to IEC/EN 60947, VDE 0660 Part 102
- Test/off pushbutton
- Reset pushbutton manual/auto
- Trip-free release

Direct mounting

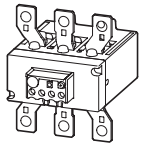

50 – 70

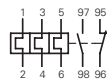

1 N/O

1 NC

DILM185A

250

160

70 – 100

1 N/O

1 NC

DILM225A

250

160

315

200

315

200

95 – 125

1 N/O

1 NC

315

250

315

250

120 – 160

1 N/O

1 NC

400

250

400

250

160 – 220

1 N/O

1 NC

400

315

500

400

200 – 250

1 N/O

1 NC

400

315

500

400

Z5 overload relays greater than 150A

- Phase failure sensitivity to IEC/EN 60947, VDE 0660 Part 102
- Test/off pushbutton
- Reset pushbutton manual/auto
- Trip-free release

Separate mounting

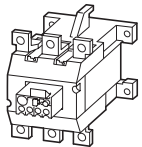

50 – 70

1 N/O

1 NC

DILM250

250

160

250

160

70 – 100

1 N/O

1 NC

315

200

315

200

95 – 125

1 N/O

1 NC

315

250

315

250

120 – 160

1 N/O

1 NC

400

250

400

250

160 – 220

1 N/O

1 NC

400

315

500

400

200 – 250

1 N/O

1 NC

400

315

500

400

250 – 300

1 N/O

1 NC

DILM300A

500

400

500

400

ZW7 current transformer-operated overload relays

- Test/off button
- Reset pushbutton manual/auto
- Trip-free release
- Protection with heavy starting duty

Separate mounting

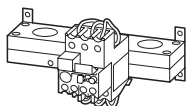

42 – 63

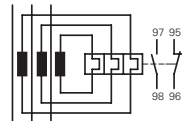

1 N/O

1 NC

–

–

–

60 – 90

1 N/O

1 NC

–

–

–

85 – 125

1 N/O

1 NC

–

–

–

110 – 160

1 N/O

1 NC

–

–

–

160 – 240

1 N/O

1 NC

–

–

–

190 – 290

1 N/O

1 NC

–

–

–

270 – 400

1 N/O

1 NC

–

–

–

360 – 540

1 N/O

1 NC

–

–

–

420 – 630

1 N/O

1 NC

–

–

–

Part no.
Article no.

Price
See price list

Std. pack

Notes

Information relevant for export to North America



Z5-70/FF225A 139572	
Z5-100/FF225A 139573	
Z5-125/FF225A 139574	
Z5-160/FF225A 139575	
Z5-220/FF225A 139576	
Z5-250/FF225A 139577	
Z5-70/FF250 210070	
Z5-100/FF250 210071	
Z5-125/FF250 210072	
Z5-160/FF250 210073	
Z5-220/FF250 210074	
Z5-250/FF250 210075	
Z5-300/FF250 139578	

1 Off

Overload release: tripping class 10 A
Short-circuit protection: With direct mounting, observe the maximum permissible fuse of the contactor.

Z5-.../FF225A for protecting EEx electric motors in preparation.

Fitted directly to the contactor

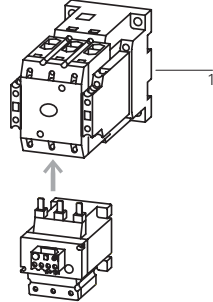

1 Contactor → Chapter 5
Accessories → Page 29

Product Standards
UL 508; CSA-C22.2 No.14; IEC/EN 60947-4-1; CE marking
Request filed for UL and CSA Branch circuits
600 V AC
IEC: IP00, UL/CSA Type: -
→ Page 31

NA Certification
Suitable for
Max. Voltage Rating
Degree of Protection
See also

Product Standards
UL 508; CSA-C22.2 No.14; IEC/EN 60947-4-1; CE marking
E29184
NKCR
12528
3211-03
UL Listed, CSA certified
Branch circuits
600 V AC
IEC: IP00, UL/CSA Type: -
→ Page 31

UL File No.
UL CCN
CSA File No.
CSA Class No.
NA Certification
Suitable for
Max. Voltage Rating
Degree of Protection
See also

Product Standards
UL 508; CSA-C22.2 No.14; IEC/EN 60947-4-1; CE marking
Request filed for UL and CSA Branch circuits
600 V AC
IEC: IP00, UL/CSA Type: -

NA Certification
Suitable for
Max. Voltage Rating
Degree of Protection

ZW7-63 000245	
ZW7-90 002618	
ZW7-125 004991	
ZW7-160 007364	
ZW7-240 009737	
ZW7-290 052448	
ZW7-400 045329	
ZW7-540 047702	
ZW7-630 050075	1 Off

1 Off

The main current characteristic values are defined by the main current wiring being used.
Adjustment for smaller rated motor currents
→ Page 30

Product Standards
UL 508; CSA-C22.2 No.14; IEC/EN 60947-4-1; CE marking
E29184
NKCR
12528
3211-03
UL Listed, CSA certified
Branch circuits
600 V AC
IEC: IP00, UL/CSA Type: -

UL File No.
UL CCN
CSA File No.
CSA Class No.
NA Certification
Suitable for
Max. Voltage Rating
Degree of Protection

1.2

Electronic overload relays to 1500 A

Basic devices

1

ZEB12, ZEB32

Ground fault detection

Setting range
of overload releases

I_r
A



Circuit symbol

Auxiliary contact

N/O = normally open contact
NC = normally closed contact

For use with

ZEB12 electronic overload relay

- Phase-failure sensitivity
- Test/off pushbutton
- Reset button
- Manual/Auto reset selectable
- Protection with heavy starting duty (Class 10A-30)

Direct mounting

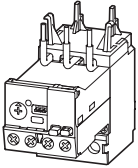

Without	0.33 – 1.65		1 N/O	1 NC	DILM7
Without	1 – 5		1 N/O	1 NC	DILM9
Without	4 – 20		1 N/O	1 NC	DILM12
With	0.33 – 1.65		1 N/O	1 NC	DILM15
With	1 – 5		1 N/O	1 NC	DIULM7
With	4 – 20		1 N/O	1 NC	DIULM9
					DIULM12
					SDAINLM12
					SDAINLM16
					SDAINLM22

ZEB32 electronic overload relay

- Phase-failure sensitivity
- Test/off pushbutton
- Reset button
- Manual/Auto reset selectable
- Protection with heavy starting duty (Class 10A-30)

Direct mounting

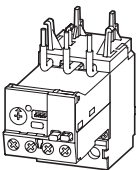

Without	0.33 – 1.65		1 N/O	1 NC	DILM17
Without	1 – 5		1 N/O	1 NC	DILM25
Without	4 – 20		1 N/O	1 NC	DILM32
Without	9 – 45		1 N/O	1 NC	DILM38
With	0.33 – 1.65		1 N/O	1 NC	DILM17
With	1 – 5		1 N/O	1 NC	DIULM17
With	4 – 20		1 N/O	1 NC	DIULM25
With	9 – 45		1 N/O	1 NC	DIULM32
					SDAINLM30
					SDAINLM45
					SDAINLM55

ZEB32 electronic overload relay

- Phase-failure sensitivity
- Test/off pushbutton
- Reset button
- Manual/Auto reset selectable
- Protection with heavy starting duty (Class 10A-30)

Separate mounting

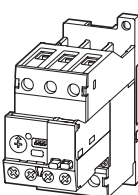







Without	0.33 – 1.65		1 N/O	1 NC	DILM17
Without	1 – 5		1 N/O	1 NC	DILM25
Without	4 – 20		1 N/O	1 NC	DILM32
Without	9 – 45		1 N/O	1 NC	DILM38
With	0.33 – 1.65		1 N/O	1 NC	DILM17
With	1 – 5		1 N/O	1 NC	DIULM17
With	4 – 20		1 N/O	1 NC	DIULM25
With	9 – 45		1 N/O	1 NC	DIULM32
					SDAINLM30
					SDAINLM45
					SDAINLM55

Information relevant for export to North America

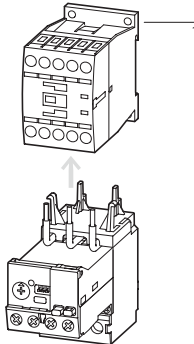
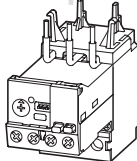

Product Standards
NA Certification
Suitable for
Max. Voltage Rating
Degree of Protection

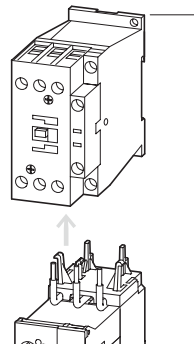
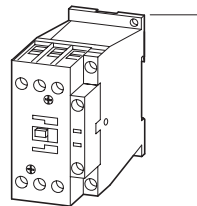
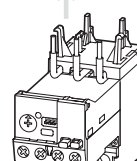
UL 508; CSA-C22.2 No.14; IEC/EN 60947-4-1; CE marking
Request filed for UL and CSA
Branch circuits
600 V AC
IEC: IP20, UL/CSA Type: -

Part no. Article no.	Price See price list	Std. pack	Notes	
ZEB12-1,65 136480		1 Off	Suitable for protection of EEx e motors.	Fitted directly to the contactor
ZEB12-5 136481			 II (2) GD PTB ATEX starting 08/2010	  1 Contactor → Chapter 5 Accessories → Page 25
ZEB12-20 136482			Observe manual AWB2320-1633D/GB.	
ZEB12-1,65-GF 136483			Switchgear and cable dimensioning according to CLASS → Page 25	
ZEB12-5-GF 136484				
ZEB12-20-GF 136485				
ZEB32-1,65 136486		1 Off	Suitable for protection of EEx e motors.	Fitted directly to the contactor
ZEB32-5 136487			 II (2) GD PTB ATEX starting 08/2010	  1 Contactor → Chapter 5 Accessories → Page 25
ZEB32-20 136488			Observe manual AWB2320-1633D/GB.	
ZEB32-45 136489			Switchgear and cable dimensioning according to CLASS → Page 25	
ZEB32-1,65-GF 136490				
ZEB32-5-GF 136491				
ZEB32-20-GF 136492				
ZEB32-45-GF 136493				
ZEB32-1,65/KK 136494		1 Off	Suitable for protection of EEx e motors.	
ZEB32-5/KK 136495			 II (2) GD PTB ATEX starting 08/2010	1 Contactor → Chapter 5 Accessories → Page 25
ZEB32-20/KK 136496			Observe manual AWB2320-1633D/GB.	
ZEB32-45/KK 136497			Switchgear and cable dimensioning according to CLASS → Page 25	
ZEB32-1,65-GF/KK 136498				
ZEB32-5-GF/KK 136499				
ZEB32-20-GF/KK 136500				
ZEB32-45-GF/KK 136501				

1.2

Electronic overload relays to 1500 A

Basic devices

1

ZEB65, ZEB150

Ground fault detection

Setting range
of overload releases

I_r
A



Circuit symbol

Auxiliary contact

N/O = normally open contact
NC = normally closed contact

For use with

ZEB65 electronic overload relay

- Phase-failure sensitivity
- Test/off pushbutton
- Reset button
- Manual/Auto reset selectable
- Protection with heavy starting duty (Class 10A-30)

Direct mounting

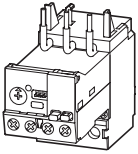

Without	9 – 45		1 N/O	1 NC	DILM40 DILM50 DILM65 DILM72 DIULM40 DIULM50 DIULM65
With	9 – 45		1 N/O	1 NC	
Without	20 – 100		1 N/O	1 NC	SDAINLM70 SDAINLM90 SDAINLM115
With	20 – 100		1 N/O	1 NC	

ZEB150 electronic overload relay

- Phase-failure sensitivity
- Test/off pushbutton
- Reset button
- Manual/Auto reset selectable
- Protection with heavy starting duty (Class 10A-30)

Direct mounting

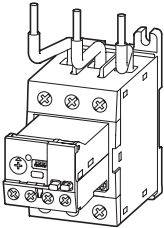

Without	20 – 100		1 N/O	1 NC	DILM80 DILM95 DILM115 DILM150 DIULM80 DIULM95 DIULM115 DIULM150
With	20 – 100		1 N/O	1 NC	SDAINLM140 SDAINLM165 SDAINLM200 SDAINLM260

ZEB150 electronic overload relay

- Phase-failure sensitivity
- Test/off pushbutton
- Reset button
- Manual/Auto reset selectable
- Protection with heavy starting duty (Class 10A-30)

Separate mounting

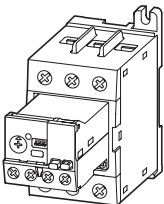

Without	20 – 100		1 N/O	1 NC	DILM80 DILM95 DILM115 DILM150 DIULM80 DIULM95 DIULM115 DIULM150
With	20 – 100		1 N/O	1 NC	SDAINLM140 SDAINLM165 SDAINLM200 SDAINLM260

Information relevant for export to North America



Product Standards
NA Certification
Suitable for
Max. Voltage Rating
Degree of Protection

UL 508; CSA-C22.2 No.14; IEC/EN 60947-4-1; CE marking
Request filed for UL and CSA
Branch circuits
600 V AC
IEC: IP20, UL/CSA Type: -

Part no.
Article no.

Price
See price list

Std. pack

Notes

ZEB65-45
136502

ZEB65-45-GF
136503

ZEB65-100
136504

ZEB65-100-GF
136505

1 Off

Suitable for protection of EEx e motors.

Ex II (2) GD
PTB ATEX starting 08/2010

Observe manual AWB2320-1633D/GB.

Switchgear and cable dimensioning according to CLASS
→ Page 25

Fitted directly to the contactor

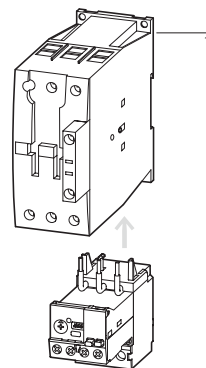

1 Contactor → Chapter 5
Accessories → Page 25

ZEB150-100
136506

ZEB150-100-GF
136507

1 Off

Suitable for protection of EEx e motors.

Ex II (2) GD
PTB ATEX starting 08/2010

Observe manual AWB2320-1633D/GB.

Switchgear and cable dimensioning according to CLASS
→ Page 25

Fitted directly to the contactor

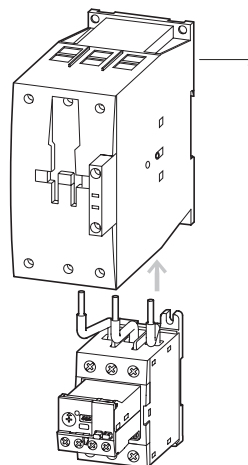

1 Contactor → Chapter 5
Accessories → Page 25

ZEB150-100/KK
136508

ZEB150-100-GF/KK
136509

1 Off

Suitable for protection of EEx e motors.

Ex II (2) GD
PTB ATEX starting 08/2010

Observe manual AWB2320-1633D/GB.

Switchgear and cable dimensioning according to CLASS
→ Page 25











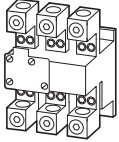

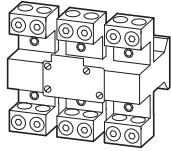

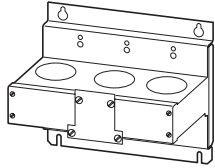
1.2

Electronic overload relays to 1500 A

Accessories

1

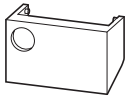
ZEB-XCT...

	Setting range of overload releases	Language	Can be used with	Part no. Article no.	Price See price list	Std. pack
	I_r A					
Current sensors						
	60 – 300	–	ZEB32-5-GF/KK ZEB32-5/KK	ZEB-XCT300¹⁾ 136511		1 off  
	120 – 600	–	ZEB32-5-GF/KK ZEB32-5/KK	ZEB-XCT600¹⁾ 136512		1 off  
	200 – 1000	–	ZEB32-5-GF/KK ZEB32-5/KK	ZEB-XCT1000¹⁾ 136517		1 off  
	300 – 1500	–		ZEB-XCT1500¹⁾ 136513		1 off  
Sealable shroud						
Cover to prevent adjustment of motor current (tamper-proof)						
	–	–	–	ZEB-XSC²⁾ 136514		1 off  
Reset adapter						
Cover to prevent adjustment of motor current (tamper-proof)						
	–	–	–	ZEB-XRB²⁾ 136515		1 off  
Documentation						
ZEB electronic overload relay Overload monitoring of EEx e motors						
	–	Deutsch English	ZEB12 ZEB32 ZEB65 ZEB150	AWB2320-1633DE/EN 136516		1 off

1)

Information relevant for export to North America



Product Standards: UL 508; CSA-C22.2 No.14; IEC/EN 60947-4-1; CE marking
 NA Certification: Request filed for UL and CSA
 Suitable for: Branch circuits
 Max. Voltage Rating: 600 V AC
 Degree of Protection: IEC: IP00, UL/CSA Type: -

2)

Information relevant for export to North America



Product Standards: UL 508; CSA-C22.2 No.14; IEC/EN 60947-4-1; CE marking
 NA Certification: Request filed for UL and CSA
 Max. Voltage Rating: 600 V AC
 Degree of Protection: IEC: IP20, UL/CSA Type: -

Switchgear and cable sizing corresponding to the respective starting inertia (CLASS) for ZEB

Switchgear is designed according to "CLASS 10" requirements for both normal and overload operation conditions. In order for the switchgear (circuit-breaker and contactor) and the cables not to be overloaded with long tripping times, they must be oversized accordingly. The rated operational current, I_o , for switchgear and cables can be calculated with the following current factor taking the tripping class into account:

Tripping class	Class 5	Class 10	Class 15	Class 20	Class 25	Class 30	Class 35	Class 40
Current factor of rated operational current I_o	1.00	1.00	1.22	1.41	1.58	1.73	1.89	2.00

Ordering

EMT6

Function	Rated operational current	Conventional thermal current	Rated control voltage	Part no. Article no.	Price See price list	Std. pack	Notes
	AC-15 240 V	AC-14 400 V					
	I_e A	I_e A	I_{th} A	U_s V			

EMT6 thermistor machine protection overload relays

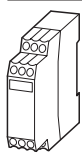

Without automatic reset Mains and fault LED display	3	3	6	24 - 240 V 50/60 Hz, 24 - 240 V DC	EMT6 ^{1) 2)} 066166	1 off	 Ex II (2) G Ex II (2) GD only for EMT6-K
				230 V 50/60 Hz	EMT6(230V) ^{1) 2)} 066400		
Without automatic reset Mains and fault LED display Tripped in the event of a short-circuit in the sensor-cable	3	3	6	24 - 240 V 50/60 Hz, 24 - 240 V DC	EMT6-K ²⁾ 269470		PTB 02 ATEX 3162

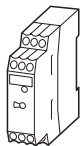

Selector switch with/without automatic reset For manual or remote resetting Test button Mains and fault LED display	3	3	6	24 - 240 V 50/60 Hz, 24 - 240 V DC	EMT6-DB ^{1) 2)} 066167		Observe the manual AWB 2327-1446 → Page 26 Can be snap fitted on a top-hat rail to IEC/EN 60715. Device clearance ≅ 3 mm.
				230 V 50/60 Hz	EMT6-DB(230V) ^{1) 2)} 066401		
Selector switch with/without automatic reset For manual or remote resetting Test button Mains and fault LED display Trip with short-circuit in the sensor cable	3	3	6	24 - 240 V 50/60 Hz, 24 - 240 V DC	EMT6-KDB ²⁾ 269471		

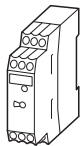

All-in-one device Selector switch with/without automatic reset Trip with short-circuit in the sensor cable Zero-voltage safe For manual or remote resetting Test button Short-circuit detection and retention can be deactivated Mains and fault LED display	3	3	6	24 - 240 V 50/60 Hz, 24 - 240 V DC	EMT6-DBK ²⁾ 066168		
---	---	---	---	---------------------------------------	---	--	--

Accessories

Screw adapters for screw fixing					CS-TE ³⁾ 095853	10 off	–
---------------------------------	--	--	--	--	--------------------------------------	--------	---

Documentation

EMT6 thermistor overload relay Overload monitoring of machines in the EEx e area							
German					AWB2327-1446D 264853	1 off	
English					AWB2327-1446GB 267010	1 off	

Notes

¹⁾ For EMT6, EMT6(230V), EMT6-DB and EMT6-DB(230V) applies:
Provide additional short-circuit protection in the sensor circuit with a current monitoring relay.

²⁾

Information relevant for export to North America

Product Standards	UL 508; CSA-C22.2 No.14; IEC/EN 60947-4-1; CE marking
UL File No.	E29184
UL CCN	NKCR
CSA File No.	12528
CSA Class No.	3211-03
NA Certification	UL Listed, CSA certified
Max. Voltage Rating	600 V AC
Degree of Protection	IEC: IP20, UL/CSA Type: -

³⁾

Information relevant for export to North America

	UL/CSA certification not required

1.2

Overload relays for machine protection

Selection aid

1

Engineering

Terminal marking according to EN 50005

EMT6(-K), EMT6(-K)DB, EMT6-DBK
Auto

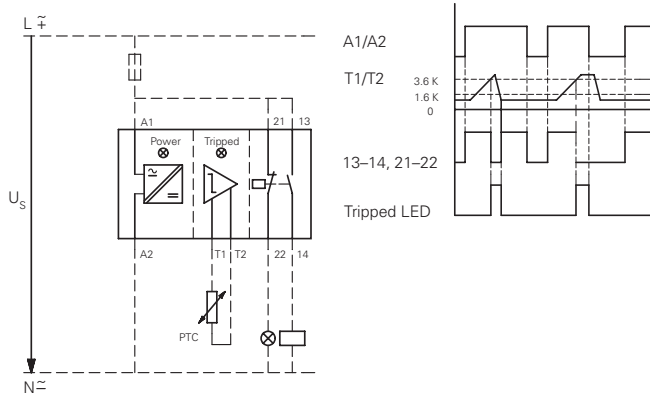

EMT6(-K)DB, EMT6-DBK
Manual

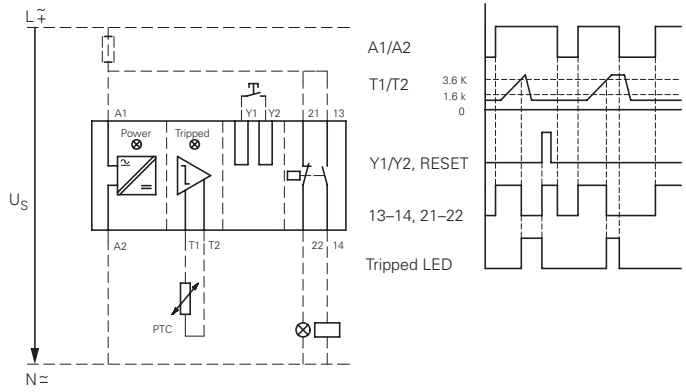

EMT6-DBK

Zero-voltage safe operation

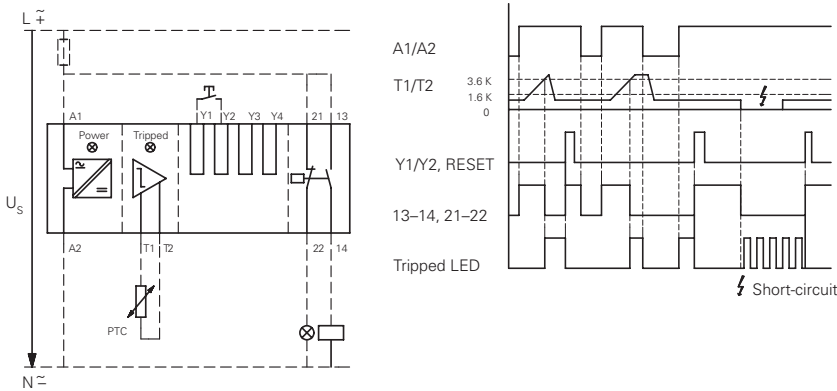

LED display

- Supply voltage present
- Device has tripped
- Device has tripped/short-circuit in the sensor circuit

Sensor circuit

At $R_K \cong 250 \Omega$ per sensor: 6 sensors, at $R_K \cong 100 \Omega$ per sensor: 9 sensors in the winding (provided by user), max. cable length to sensor 250 m (not shielded); Total PTC thermistor resistance $\sum R_K \cong 1500 \Omega$

Sensor circuit characteristic values at U_S and $+20^\circ \text{C}$

	EMT6...	
R_{T1-T2}	U_{T1-T2} V DC max.	I_{T1-T2} mA max.
T1, T2 short-circuited	-	1.9
4 k Ω	3	0.8
T1-T2 open	5.1	-





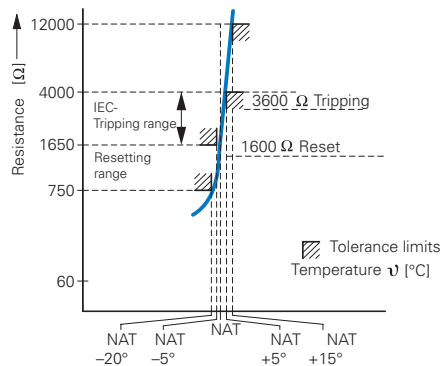

























Functions that can be disconnected on the EMT6-DBK:

Function	Disconnection by link
Short-circuit monitoring	Y ₁ - Y ₃
Zero-voltage safety	Y ₁ - Y ₄



Ordering

ZB, Z5, ZW7

	For use with	Part no. Article no.	Price See price list	Std. pack	Notes	 	Information relevant for export to North America	
Documentation Overload relays Overload monitoring of EEx e motors	ZE...	AWB2300-1425D 258704		1 off	German			
	ZB12... ZB32...	AWB2300-1527D/GB 284910		1 off	German/English			
	ZB65... ZB150...	AWB2300-1545D/GB 102065		1 off	German/English			
Bases For separate mounting	ZB32	ZB32-XEZ 278473		5 off  	Can be snap fitted on a top-hat rail to IEC/EN 60715 or can be screw fitted.	 	Product Standards UL File No. UL CCN CSA File No. CSA Class No. NA Certification Max. Voltage Rating Degree of Protection	UL 508; CSA-C22.2 No.14; IEC/EN 60947-4-1; CE marking E29184 NKCR 12528 3211-03 UL Listed, CSA certified 600 V AC IEC: IP00, UL/CSA Type: -
	ZB65	ZB65-XEZ 278474		2 off  	For ZB32-38, use BK25/3-PKZ0 additionally.	 		
Pushbuttons For enclosed Overload relay Mounting diameter: 22.3 mm External reset button, IP65	ZW7... ZE Z5 ZB12 ZB32 ZB65 ZB150	M22-DZ-B 254833		10 off  	Button plate, blue	 	Product Standards UL File No. UL CCN CSA File No. CSA Class No. NA Certification	UL 508; CSA-C22.2 No.14; IEC/EN 60947-4-1; CE marking E29184 NKCR 12528 3211-03 UL Listed, CSA certified
	ZW7... ZE Z5 ZB12 ZB32 ZB65 ZB150	M22-DZ-B-GB14 254834		10 off  	Button plate, blue RESET	 		
Pushbuttons For enclosed Overload relay Mounting diameter: 22.3 mm Off button, IP65	ZW7... ZE Z5 ZB12 ZB32 ZB65 ZB150	M22-DZ-X 254835		10 off  	Without button plate, add button plate.	 	Product Standards UL File No. UL CCN CSA File No. CSA Class No. NA Certification	UL 508; CSA-C22.2 No.14; IEC/EN 60947-4-1; CE marking E29184 NKCR 12528 3211-03 UL Listed, CSA certified
	ZW7... ZE Z5 ZB12 ZB32 ZB65 ZB150	M22-DZ-X-GB14 254836		10 off  	Without button plate, add button plate.	 		
Pushbuttons For enclosed Overload relay Mounting diameter: 22.3 mm Button plates	M22-DZ-X	M22-XD-R 216423		10 off  	Button plate, red	 	UL/CSA certification not required	
	M22-DZ-X	M22-XD-R-X0 218153			Red button plate with white circle			
	M22-DZ-X	M22-XD-R-GB0 218194			Button plate red STOP			

1.2

Overload relays

Accessories

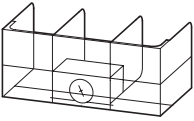
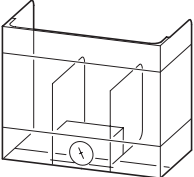

1

Z5..., K-B..., KS-B...

	For use with	Part no. Article no.	Price See price list	Std. pack	Notes		
Covers 	Direct mounting Z5-.../FF225 to DILM185A DILM225A	Z5/FF225A-XHB-Z 139579		1 off	Fitted directly to the contactor <div style="border: 1px solid black; padding: 2px; display: inline-block;">DILM400 -XHB</div> <div style="border: 1px solid black; padding: 2px; display: inline-block;">DILM185A/ 225A</div> <div style="border: 1px solid black; padding: 2px; display: inline-block;">Z5/FF225A -XHB-Z</div> <div style="border: 1px solid black; padding: 2px; display: inline-block;">Z5-.../FF225A</div> <div style="border: 1px solid black; padding: 2px; display: inline-block;">Z5/FF250 -XHB</div>		
	Z5-.../FF225A Z5-.../FF250	Z5/FF250-XHB 215217		1 off	Separate mounting <div style="border: 1px solid black; padding: 2px; display: inline-block;">Z5/FF250 -XHB</div> <div style="border: 1px solid black; padding: 2px; display: inline-block;">Z5-.../FF250/ FF225A</div> <div style="border: 1px solid black; padding: 2px; display: inline-block;">Z5/FF250 -XHB</div>	Fitted directly to the contactor <div style="border: 1px solid black; padding: 2px; display: inline-block;">DILM400 -XHB</div> <div style="border: 1px solid black; padding: 2px; display: inline-block;">DILM250/ 300A</div> <div style="border: 1px solid black; padding: 2px; display: inline-block;">Z5/FF250 -XHB-Z</div> <div style="border: 1px solid black; padding: 2px; display: inline-block;">Z5-.../FF250</div> <div style="border: 1px solid black; padding: 2px; display: inline-block;">Z5/FF250 -XHB</div>	Fitted directly to the contactor <div style="border: 1px solid black; padding: 2px; display: inline-block;">DILM400 -XHB</div> <div style="border: 1px solid black; padding: 2px; display: inline-block;">DILM185A/ 225A</div> <div style="border: 1px solid black; padding: 2px; display: inline-block;">Z5/FF225A -XHB-Z</div> <div style="border: 1px solid black; padding: 2px; display: inline-block;">Z5-.../FF225A</div> <div style="border: 1px solid black; padding: 2px; display: inline-block;">Z5/FF250 -XHB</div>
	Covers 	Direct mounting Z5-.../FF250 to DILM250 DILM300A	Z5/FF250-XHB-Z 215218		1 off	Fitted directly to the contactor <div style="border: 1px solid black; padding: 2px; display: inline-block;">DILM400 -XHB</div> <div style="border: 1px solid black; padding: 2px; display: inline-block;">DILM250/ 300A</div> <div style="border: 1px solid black; padding: 2px; display: inline-block;">Z5/FF250 -XHB-Z</div> <div style="border: 1px solid black; padding: 2px; display: inline-block;">Z5-.../FF250</div> <div style="border: 1px solid black; padding: 2px; display: inline-block;">Z5/FF250 -XHB</div>	

Box terminals kit

Consisting of 3 individual clamps

	For use with	For connection of copper flat strip max. W × H mm	Part no. Article no.	Price See price list	Std. pack	Notes
With protective cover 	Z5-.../FF250	24 × 26	K-B-DIL6AM 064062		1 off	When using box terminals the protective covers must be used.
With control circuit terminal and protective cover 	Z5-.../FF250	24 × 26	KS-B-DIL6AM 064063		1 off	When using box terminals the protective covers must be used.

for North America
Engineering

Protection of single-phase and DC current motors:

1 pole

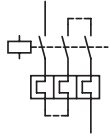

2 pole

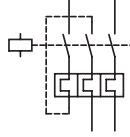

Mounting position:

ZE

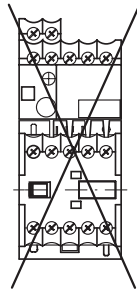
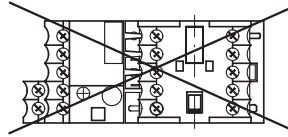

ZB12, ZB32, ZB65, ZB150, Z5

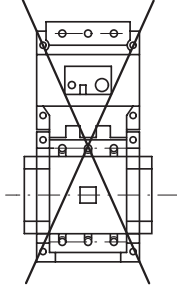

Tripping characteristics

These tripping characteristics are mean values of the spread at 20 °C ambient temperature in a cold state. They show the tripping times in relation to the response current. When the devices are at operational temperature the tripping time of the overload relay drops to approx. 25% of the value shown. Specific characteristics for each individual setting range can be found in the manual on → Page 28

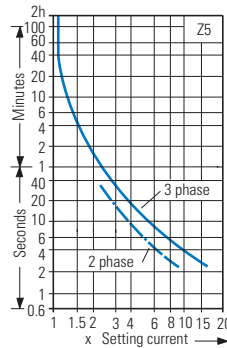
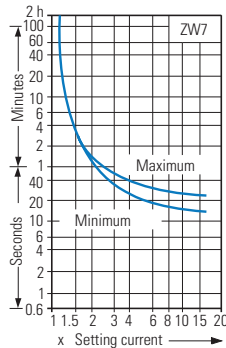
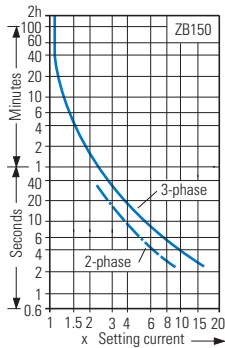
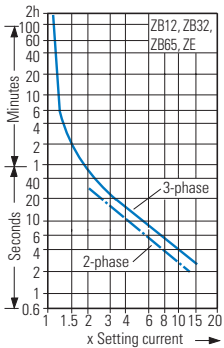

Adaption of ZW7 to smaller rated motor currents

Number of loops	ZW7 -63	-90	-125	-160	-240	-290	-400	-540	-630
	Rated motor current I_N [A]								
1	42-63	60-90	85-125	110-160	160-240	190-290	270-400	360-540	420-630
2	21-31,5	30-45	42,5-62,5	55-80	80-120	95-145	135-200	180-270	210-315
3	14-21	20-30	28,3-41,7	36,7-53,3	53,3-80	63,3-96,7	90-133,3	120-180	140-210
4	10,5-15,8	15-22,5	21,3-31,3	27,5-40	40-60	47,5-72,5	67,5-100	90-135	105-157,5
5	8,4-12,6	12-18	17-25	22-32	32-48	38-58	54-80	72-108	84-126

1.2

Overload relays UL/CSA-short-circuit strength

1

For North America

ZE, ZB, Z5 Overload relay short-circuit strength



UL508, CSA-C22.2 No. 14/SCCR values

	Fuse acc. to NEC, CEC		CB	
	A	kA	A	kA
	600V AC		480V AC	
ZE-0,16	1	5	15	5
ZE-0,24	1	5	15	5
ZE-0,4	1	5	15	5
ZE-0,6	1	5	15	5
ZE-1,0	3	5	15	5
ZE-1,6	6	5	15	5
ZE-2,4	6	5	15	5
ZE-4	15	5	15	5
ZE-6	20	5	15	5
ZE-9	35	5	15	5
ZE-12	45	5	-	-
	600V AC		600V AC	
ZB12(32)-0,16	1 CLASS J/CC	100	-	-
ZB12(32)-0,24	1 CLASS J/CC	100	-	-
ZB12(32)-0,4	1 CLASS J/CC	100	-	-
ZB12(32)-0,6	1 CLASS J/CC	100	-	-
ZB-12(32)-1,0	1 CLASS J/CC	100	-	-
ZB-12(32)-1,6	3 CLASS J/CC	100	-	-
ZB-12(32)-2,4	3 CLASS J/CC	100	-	-
ZB-12(32)-4	6 CLASS J/CC	100	-	-
ZB-12(32)-6	10 CLASS J/CC	100	-	-
ZB-12(32)-10	15 CLASS J/CC	100	-	-
ZB12-12	15 CLASS J/CC	100	-	-
ZB12-16	30 CLASS J/CC	100	-	-
ZB32-16	35 CLASS J	100	-	-
ZB32-24	45 CLASS J	100	-	-
ZB32-32	60 CLASS J	100	-	-
	600V AC		600V AC	
ZB65-10	15 CLASS J	100	40	5
ZB65-16	35 CLASS J	100	60	5
ZB65-24	45 CLASS J	100	90	5
ZB65-40	60 CLASS J	100	125	5
ZB65-57	110 CLASS J	100	150	10
ZB65-65	125 CLASS J	100	150	10
ZB65-75	125 CLASS J	100	150	10

	Fuse acc. to NEC, CEC		CB	
	A	kA	A	kA
	600V AC		600 V AC	
ZB150-50	225	5	200	5
ZB150-70	250	10	250	10
ZB150-100	400 CLASS J	10	400	10
ZB150-125	500 CLASS J	10	500	10
ZB150-150	600 CLASS J	10	600	10
ZB150-175	600 CLASS J	10	600	10
ZB150-50(KK)	110 CLASS J	100	200	5
ZB150-70(KK)	125 CLASS J	100	250	10
ZB150-100(KK)	200 CLASS J	100	400	10
ZB150-125(KK)	250 CLASS J	100	500	10
ZB150-150(KK)	300 CLASS J	100	600	10
ZB150-175(KK)	300 CLASS J	100	600	10
	600V AC		600V AC	
Z5-70/...	250	10	250	10
Z5-100/...	400 CLASS J	10	400	10
Z5-125/...	500 CLASS J	10	500	10
Z5-160/...	600 CLASS J	10	600	10
Z5-220/...	800 CLASS J	10	800	10
Z5-250/...	700 CLASS J	10	600	10
Z5-70/...	125 CLASS J	100	-	-
Z5-100/...	200 CLASS J	100	-	-
Z5-125/...	250 CLASS J	100	-	-
Z5-160/...	300 CLASS J	100	-	-

Technical data

ZE, ZB

			ZE	ZB12, ZB32	ZB65	ZB150(KK)
General						
Standards			IEC/EN 60947, VDE 0660, UL, CSA			
Climatic proofing			Damp heat, constant, to IEC 60068-2-78 Damp heat, cyclic, to IEC 60068-2-30			
Ambient temperature						
Open ¹⁾	°C		-25...50	-25...55	-25...55	-25...55
Enclosed ¹⁾	°C		-25...40	-25...40	-25...40	-25...40
Temperature compensation			Continuous			
Mounting position			→ Page 30			
Weight	kg		0.07	0.15	0.25	1.64
Mechanical shock resistance half-sinusoidal shock, 10 ms to IEC 60068-2-27	g		10	10	10	10
Protection type			IP20	IP20	IP00	IP00
Protection against direct contact when actuated from front (EN 50274)			Finger- and back-of-hand proof			
Main contacts						
Rated impulse withstand voltage	U_{imp}	V AC	6000	6000	6000	8000
Overvoltage category/pollution degree			III/3	III/3	III/3	III/3
Rated insulation voltage						
AC	U_i	V AC	690	690	690	1000
Rated operating voltage	U_e	V AC	690	690	690	1000
Safe isolation according to EN 61140						
Between auxiliary contacts and main contacts		V AC	300	440	440	440
Between the main contacts		V AC	300	440	440	440
Overload relay setting range	A		0.1...12	0.1...38	6...75	25...175
Temperature compensation residual error > 40 °C	%/K		≤ 0.25	≤ 0.25	≤ 0.25	≤ 0.25
Short-circuit protection rating maximum fuse			→ Page 13	→ Page 15	→ Page 17	→ Page 17
Current heat loss (3 conductors)						
Lower value of setting range	W		2.5	2.5	3	16
Upper value of setting range	W		6	6	7.5	18
Terminal capacity						
Solid	mm ²		2 × (0.75 - 2.5)	2 × (1 - 6) ⁵⁾	2 × (1 - 16) ⁴⁾	2 × (4 - 16)
Flexible with ferrule	mm ²		2 × (0.5 - 1.5)	2 × (1 - 4) ⁵⁾ 2 × (1 - 6) ³⁾	1 × (1...25) ²⁾ 2 × (1...10) ²⁾	1 × (4 - 70) 2 × (4 - 50)
Stranded	mm ²		–	–	1 × (16...25)	1 × (16...50) 2 × (16...50)
Solid or stranded	AWG		18 - 14	14 - 8 ⁵⁾	14 - 2	3/0
Busbar	Width	mm	–	–	–	–
Terminal screw			M3.5	M4	M6	M10
Tightening torque	Nm		1.2	1.8 ⁵⁾	3.5	10
Tools						
Pozidriv screwdriver	Size		2	2	2	–
Flat-blade screwdriver	mm		0.8 × 5.5	1 × 6	1 × 6	–
Hexagon socket	SW	mm	–	–	–	5

Notes

- ¹⁾ Ambient temperature: Operating range to IEC/EN 60947, PTB: -5°C to +55°C
- ²⁾ Use identical cross-section when using two conductors
- ³⁾ 6 mm flexible with ferrules to DIN 46228
- ⁴⁾ With ZB65-XEZ max 1 × (1... 16)
- ⁵⁾ ZB32-38: solid and flexible with ferrule, 2.5 - 25 mm², 3 Nm tightening torque. AWG10-b, 27 lb-in tightening torque for solid or stranded conductors.

1.2

Overload relays

Overload relays, CT-operated overload relays

1

Z5, ZW7

		Z5-.../FF225A(250)		ZW7
General				
Standards		IEC/EN 60947, VDE 0660, UL, CSA		IEC/EN 60947, VDE 0660, UL, CSA
Climatic proofing		Damp heat, constant, to IEC 60068-2-78 Damp heat, cyclic, to IEC 60068-2-30		
Ambient temperature				
Open ¹⁾	°C	-25...50		-25...50
Enclosed ¹⁾	°C	-25...40		-25...40
Temperature compensation		Continuous		Continuous
Mounting position		→ Page 30		Any
Weight	kg	1.55		0.8
Mechanical shock resistance half-sinusoidal shock, 10 ms to IEC 60068-2-27	g	10		10
Protection type		IP00		IP00
Protection against direct contact when actuated from front (EN 50274)		With terminal cover		Finger- and back-of-hand proof
Main contacts				
Rated impulse withstand voltage	U_{imp}	V AC	8000	6000
Overvoltage category/pollution degree			III/3	III/3
Rated insulation voltage				
AC	U_i	V AC	1000	690
Rated operating voltage	U_e	V AC	1000	690
Safe isolation according to EN 61140				
Between auxiliary contacts and main contacts		V AC	440	440
Between the main contacts		V AC	440	440
Overload relay setting range		A	50...300	42...630
Temperature compensation residual error > 40 °C		%/K	≤ 0.25	–
Short-circuit protection rating maximum fuse			→ Page 19	With overload relay in conjunction with a transformer as required for the contactor
Current heat loss (3 conductors)				
Lower value of setting range		W	16	3
Upper value of setting range		W	28	10
Terminal capacity				
Flexible with ferrule		mm ²	95	–
Stranded with ferrule		mm ²	120	–
Solid or stranded		AWG	250 MCM	–
Flat conductor.	Number of segments × width × thickness	mm	6 × 16 × 0.8 ²⁾	–
Busbar	Width	mm	20 × 3	–
Push-through opening	∅	mm	–	27
Terminal screw			M8 × 25	–
Tightening torque		Nm	24	–
Tools				
Hexagonal socket		SW	mm	13

Notes

¹⁾ Ambient temperature: Operating range to IEC/EN 60947, PTB: -5°C to +50°C

²⁾ Fixing with box terminals

ZE, ZB, Z5, ZW7

1

			ZE	ZB12, ZB32	ZB65	ZB150(KK)	Z5-.../FF225 Z5-.../FF250	ZW7
Auxiliary and control circuits								
Rated impulse withstand voltage	U_{imp}	V	6000	6000	6000	6000	6000	6000
Overvoltage category/Pollution degree			III/3	III/3	III/3	III/3	III/3	III/3
Terminal capacity								
Solid		mm ²	2 × (0.75 - 2.5)	2 × (0.75 - 4)	2 × (0.75 - 4)	2 × (0.75 - 4)	2 × (0.75 - 4)	2 × (0.75 - 4)
Flexible with ferrule		mm ²	2 × (0.5 - 1.5)	2 × (0.75 - 2.5)	2 × (0.75 - 2.5)	2 × (0.75 - 2.5)	2 × (0.75 - 2.5)	2 × (0.75 - 2.5)
Solid or stranded		AWG	2 × (18 - 12)	2 × (18 - 12)	2 × (18 - 12)	2 × (18 - 12)	2 × (18 - 12)	2 × (18 - 12)
Terminal screw			M3.5	M3.5	M3.5	M3.5	M3.5	M3.5
Tightening torque		Nm	0.8 - 1.2	0.8 - 1.2	0.8 - 1.2	0.8 - 1.2	0.8 - 1.2	0.8 - 1.2
Tools								
Pozidriv screwdriver		Size	2	2	2	2	2	2
Flat-blade screwdriver		mm	0.8 × 5.5	1 × 6	1 × 6	1 × 6	1 × 6	1 × 6
Auxiliary circuit rated insulation voltage	U_i	V AC	690	500	500	500	500	500
Rated operating voltage	U_e	V AC	500	500	500	500	500	500
Safe isolation according to EN 61140								
Between the auxiliary contacts		V AC	300	240	240	240	240	240
Conventional thermal current	I_{th}	A	6	6	6	6	6	6
Rated operational current								
AC-15								
N/O								
	120 V	I_e	A	1.5	1.5	1.5	1.5	1.5
	240 V	I_e	A	1.5	1.5	1.5	1.5	1.5
	415 V	I_e	A	0.5	0.5	0.5	0.5	0.5
	500 V	I_e	A	0.3	0.5	0.5	0.5	0.5
NC								
	120 V	I_e	A	1.5	1.5	1.5	1.5	1.5
	240 V	I_e	A	1.5	1.5	1.5	1.5	1.5
	415 V	I_e	A	0.7	0.9	0.9	0.9	0.9
	500 V	I_e	A	0.5	0.8	0.8	0.8	0.8
DC-13 L/R ≤ 15 ms ¹⁾								
	24 V	I_e	A	0.9	0.9	0.9	0.9	0.9
	60 V	I_e	A	0.75	0.75 ³⁾	0.75 ³⁾	0.75 ³⁾	0.75 ³⁾
	110 V	I_e	A	0.4	0.4	0.4	0.4	0.4
	220 V	I_e	A	0.2	0.2	0.2	0.2	0.2
General Use								
AC operated		V	240 600	–	–	–	–	–
AC operated		A	1.5 0.6	–	–	–	–	–
DC operated		V	–	–	–	–	–	–
DC operated		A	–	–	–	–	–	–
Pilot Duty								
AC operated			D300	B300 ⁴⁾ B600 ⁵⁾	B300 ⁴⁾ B600 ⁵⁾	B300 ⁴⁾ B600 ⁵⁾	B300 ⁴⁾ B600 ⁵⁾	B300 ⁴⁾ B600 ⁵⁾
DC operated			R300	R300	R300	R300	R300	R300
Short-circuit rating without welding								
Max. fuse ²⁾		A gG/gL	4	6	6	6	6	6

Notes

- 1) Making and breaking conditions to DC-13, time constant as stated
- 2) See transparent overlay "Fuses" for time/current characteristics (please enquire)
- 3) Rated operational current DC-13, 60 V: N/O auxiliary contact 0.6 A
- 4) With opposite polarity
- 5) With same polarity

1.2

Electronic overload relays to 1500 A

1

ZEB			ZEB12, ZEB32	ZEB65-45	ZEB65-100	ZEB150	
General							
Standards	IEC/EN 60947, VDE 0660, UL, CSA						
Climatic proofing	Damp heat, constant, to IEC 60068-2-78 Damp heat, cyclic, to IEC 60068-2-30						
Ambient temperature							
Open	°C		-25...65	-25...65	-25...65	-25...65	
Enclosed	°C		-25...65	-25...40	-25...40	-25...40	
Temperature compensation	Continuous						
Mounting position	Any						
Mechanical shock resistance half-sinusoidal shock, 10 ms to IEC 60068-2-27	g		15	15	15	15	
Protection type	IP20						
Protection against direct contact when actuated from front (EN 50274)	Finger- and back-of-hand proof						
Main contacts							
Rated impulse withstand voltage	U_{imp}	V AC	6000	6000	6000	6000	
Overvoltage category/pollution degree	III / 3						
Rated insulation voltage							
AC	U_i	V AC	690	690	690	690	
Rated operating voltage	U_e	V AC	690	690	690	690	
Safe isolation according to EN 61140							
Between auxiliary contacts and main contacts	V AC		600	600	600	600	
Between the main contacts	V AC		600	600	600	600	
Overload relay setting range	A		0.3...45	9...45	20...100	20...100	
Terminal capacity							
Solid	mm ²		1 × 2.5 - 16	1 × 2.5 - 16	1 × 6 - 50	1 × 6 - 50	
Solid or stranded	AWG		1 × 14 - 4	1 × 14 - 4	1 × 10 - 1	1 × 10 - 1	
Auxiliary and control circuits							
Rated impulse withstand voltage	U_{imp}	V	6000	6000	6000	6000	
Overvoltage category/pollution degree	III / 3						
Terminal capacity							
Solid	mm ²		2 × (0.75 - 4)	2 × (0.75 - 4)	2 × (0.75 - 4)	2 × (0.75 - 4)	
Flexible with ferrule	mm ²		2 × (0.75 - 2.5)	2 × (0.75 - 2.5)	2 × (0.75 - 2.5)	2 × (0.75 - 2.5)	
Solid or stranded	AWG		2 × (18 - 12)	2 × (18 - 12)	2 × (18 - 12)	2 × (18 - 12)	
Terminal screw	M3.5						
Tightening torque	Nm		0.8 - 1.2	0.8 - 1.2	0.8 - 1.2	0.8 - 1.2	
Tightening torque	lb-in		7 - 10.6	7 - 10.6	7 - 10.6	7 - 10.6	
Tools							
Pozidriv screwdriver	Size		2	2	2	2	
Flat-blade screwdriver	mm		1 × 6	1 × 6	1 × 6	1 × 6	
Auxiliary circuit rated insulation voltage	U_i	V AC	500	500	500	500	
Rated operating voltage	U_e	V AC	500	500	500	500	
Safe isolation according to EN 61140							
Between the auxiliary contacts	V AC		240	240	240	240	
Conventional thermal current	I_{th}	A	5	5	5	5	
Rated operational current							
AC-15							
N/O	120 V	I_e	A	1.5	1.5	1.5	1.5
	240 V	I_e	A	1.5	1.5	1.5	1.5
	415 V	I_e	A	0.5	0.5	0.5	0.5
	500 V	I_e	A	0.5	0.5	0.5	0.5
NC	120 V	I_e	A	1.5	1.5	1.5	1.5
	240 V	I_e	A	1.5	1.5	1.5	1.5
	415 V	I_e	A	0.9	0.9	0.9	0.9
	500 V	I_e	A	0.8	0.8	0.8	0.8
DC-13 L/R ≅ 15 ms							
24 V	I_e	A	0.9	0.9	0.9	0.9	
60 V	I_e	A	0.75	0.75	0.75	0.75	
110 V	I_e	A	0	0.4	0.4	0.4	
220 V	I_e	A	0.2	0.2	0.2	0.2	
Short-circuit rating without welding							
Max. fuse	A gG/gL		6	6	6	6	

EMT6
EMT6
General

Standards	IEC/EN 60947, VDE 0660, EN 55011		
Climatic proofing	Damp heat, constant, to IEC 60068-2-78; Damp heat, cyclic, to IEC 60068-2-30		
Ambient temperature			
Open	°C	-25...60	
Enclosed	°C	-25...45	
Storage	°C	-45 - 60	
Mounting position	Any		
Weight	kg	0.15	
Shock resistance half-sinusoidal shock 10 ms to IEC 60068-2-27	g	10	
Protection type	IP20		
Protection against direct contact when actuated from front (EN 50274)	Finger- and back-of-hand proof		
Safe isolation according to EN 61140			
Between the contacts	V AC	250	
Between contacts and supply voltage	V AC	250	

Auxiliary and control circuits

Rated impulse withstand voltage	U_{imp}	V AC	6000	
Overvoltage category/pollution degree	III/3			
Auxiliary and control circuit terminal capacity				
Solid	mm ²	1 × 2.5 2 × (0.5 - 1.5)		
Flexible with ferrule	mm ²	1 × 2.5 2 × (0.5 - 1.5)		
Solid or stranded	AWG	20 - 14		
Terminal screw	M3.5			
Tightening torque	Nm	1.2		
Tools				
Pozidriv screwdriver	Size	2		
Flat-blade screwdriver	mm	1 × 6		

Auxiliary circuit

Rated insulation voltage	U_i	V	400	
Rated operational current				
AC-14				
N/O	415 V	I_e	A	3
NC	415 V	I_e	A	3
AC-15				
N/O	240 V	I_e	A	3
	415 V	I_e	A	1
NC	240 V	I_e	A	3
	415 V	I_e	A	1
Max. short-circuit protective device				
Fuse	gG/gL	A	6	

Control circuit

Rated insulation voltage	U_i	V	240	
Rated operational voltage	U_e	V	240 ¹⁾	
Voltage tolerance			x U_e	0.85 - 1.1
Power consumption				
AC			VA	3.5
DC			W	2
Trip at approx.			Ω	\cong 3600
Reset at approx.			Ω	\cong 1600

Notes
¹⁾ EMT6(-DB)230V: $U_e = 230$ V

1.2

Overload relays

Overload relays

1

Dimensions

Overload relays

ZE...

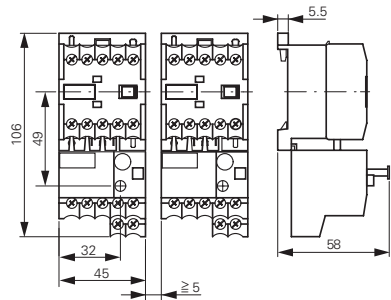

Base

ZB32-XEZ

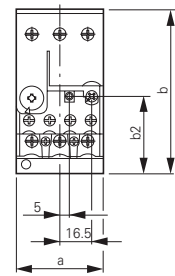

ZB65-XEZ

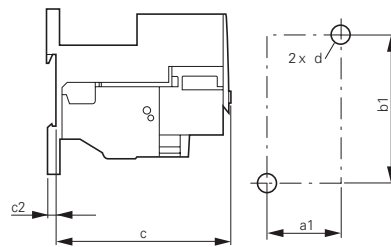

	ZB32	ZB65
a	45	60
b	85	86
c	90.5	112
c2	3.8	4.7
a1	35	50
b1	75	75
b2	40.5	47
d	M4	M5

ZB12

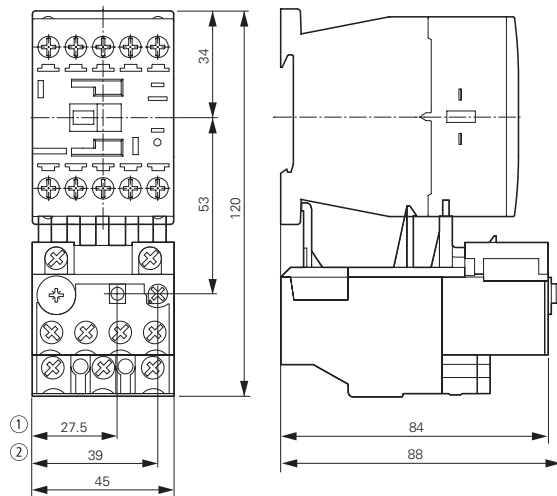

- ① OFF
- ② Reset/ON

ZB32

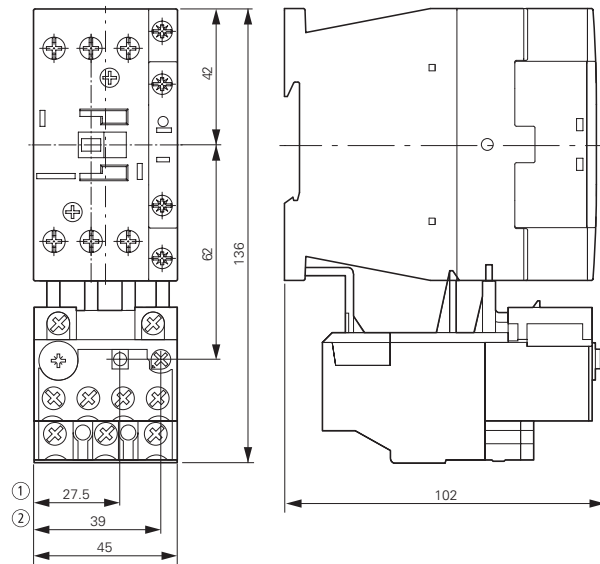

ZB32-38

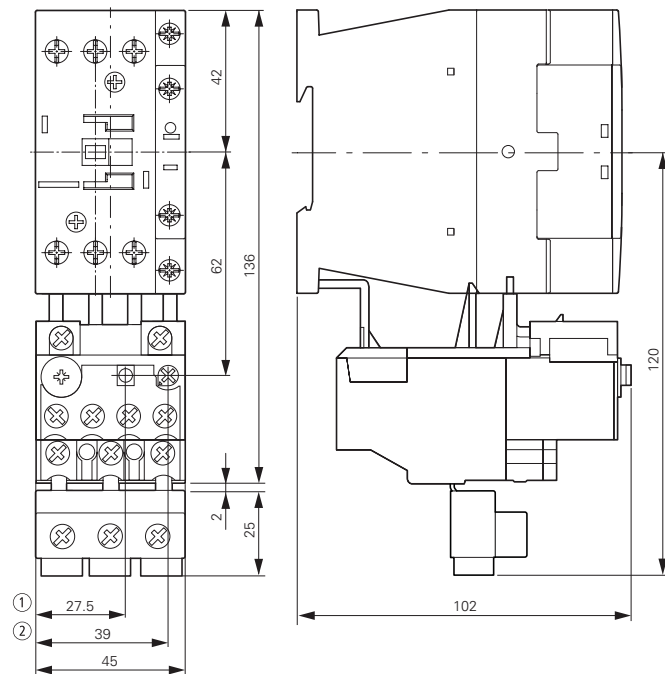

- ① OFF
- ② Reset/ON

Overload relays

ZB65

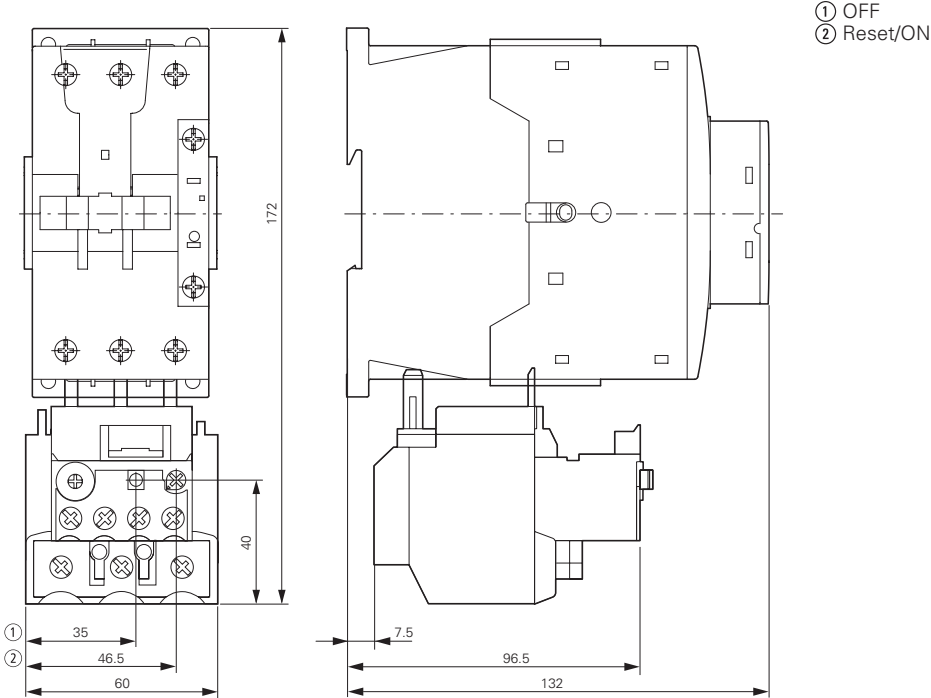

ZB150

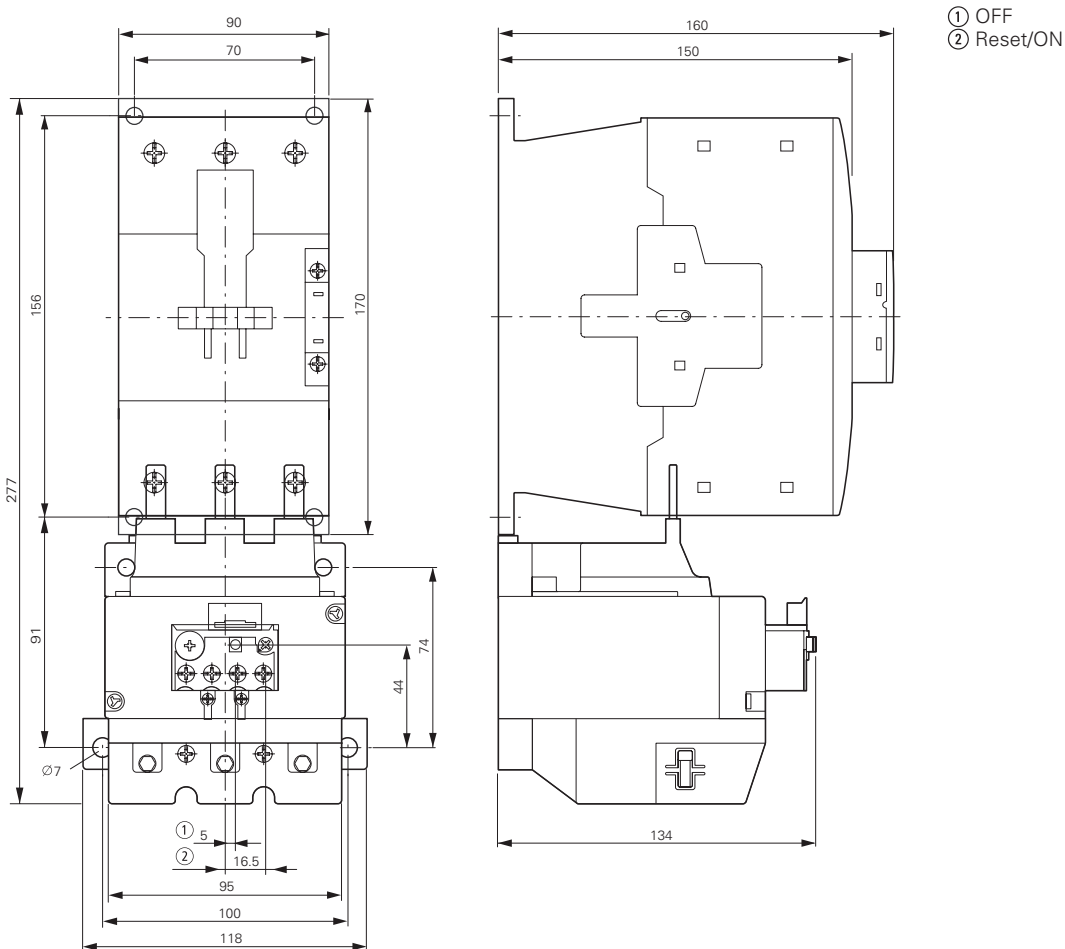

1.2

Overload relays

Overload relays, CT-operated overload relays

1

Overload relays

ZB150-50/KK

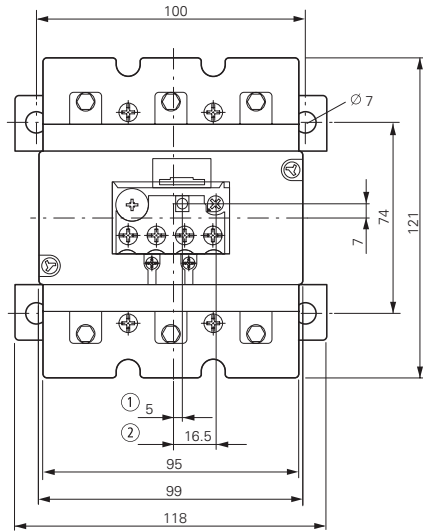

- ① OFF
- ② Reset/ON

Z5 overload relays greater than 150A

Z5.../FF250

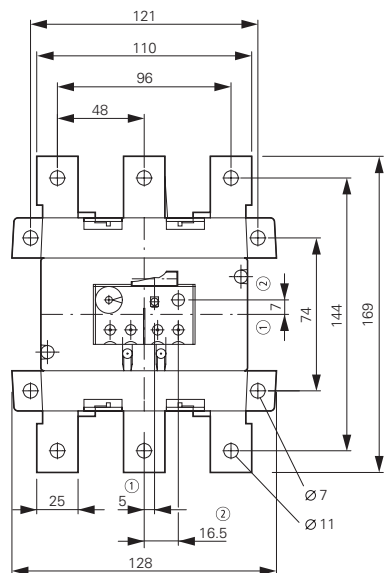

- ① OFF
- ② Reset/ON

Current transformer-operated overload relays

ZW7-...

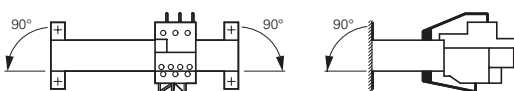
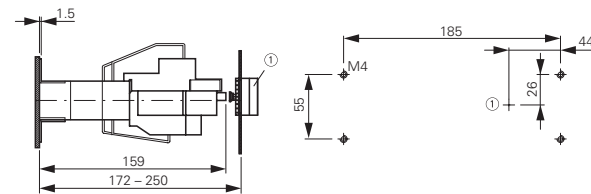
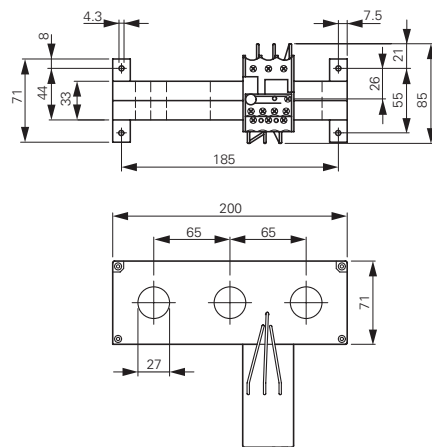

- ① Reset/ON

Electronic overload relays

ZEB12

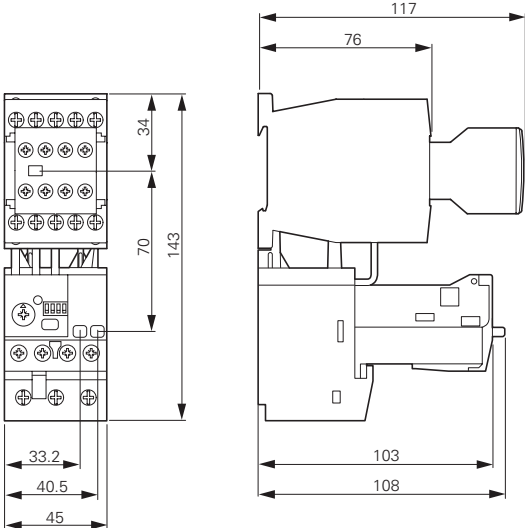

ZEB32

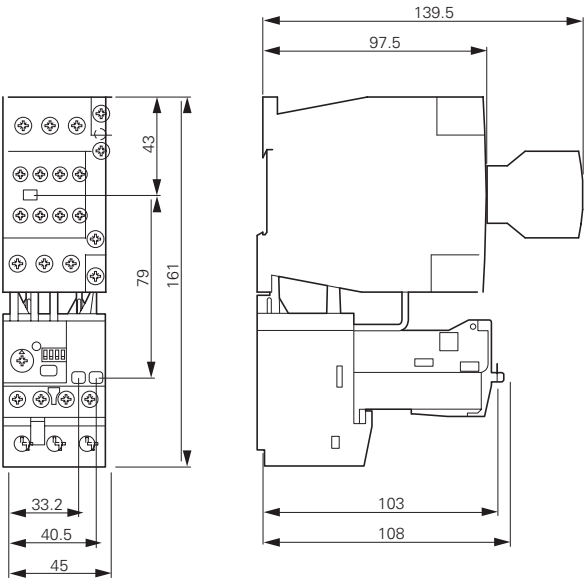

ZEB65-45

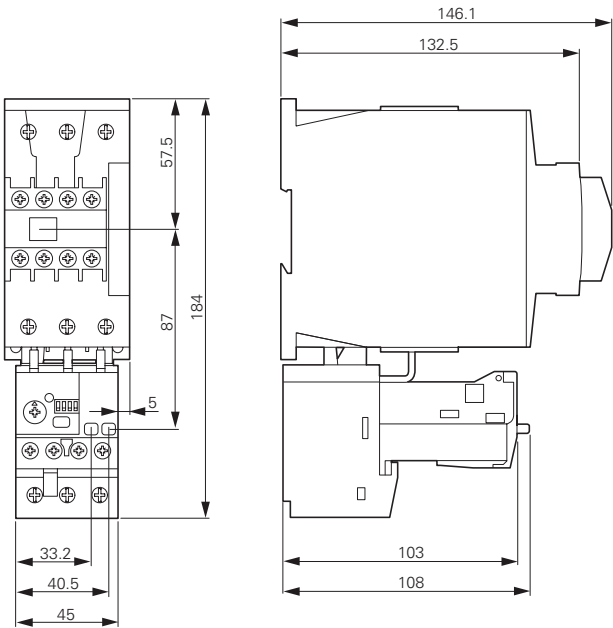

ZEB65-100

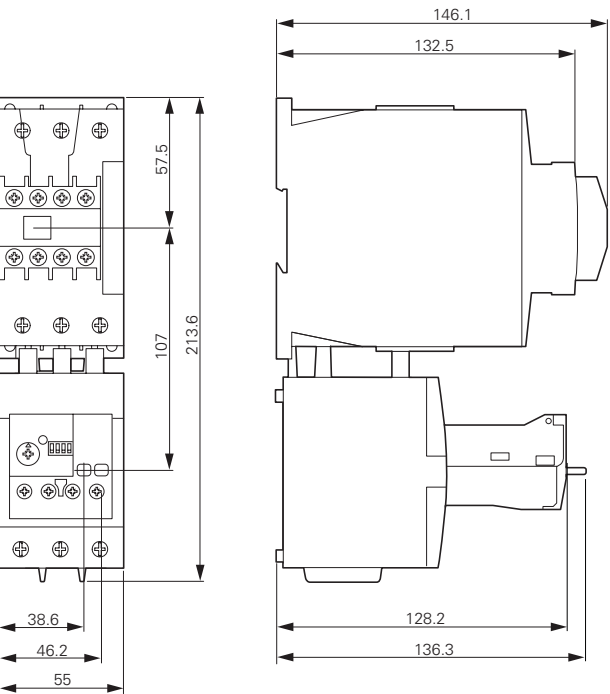

1.2

Overload relays

Electronic overload relays

1

Electronic overload relays

ZEB150-100

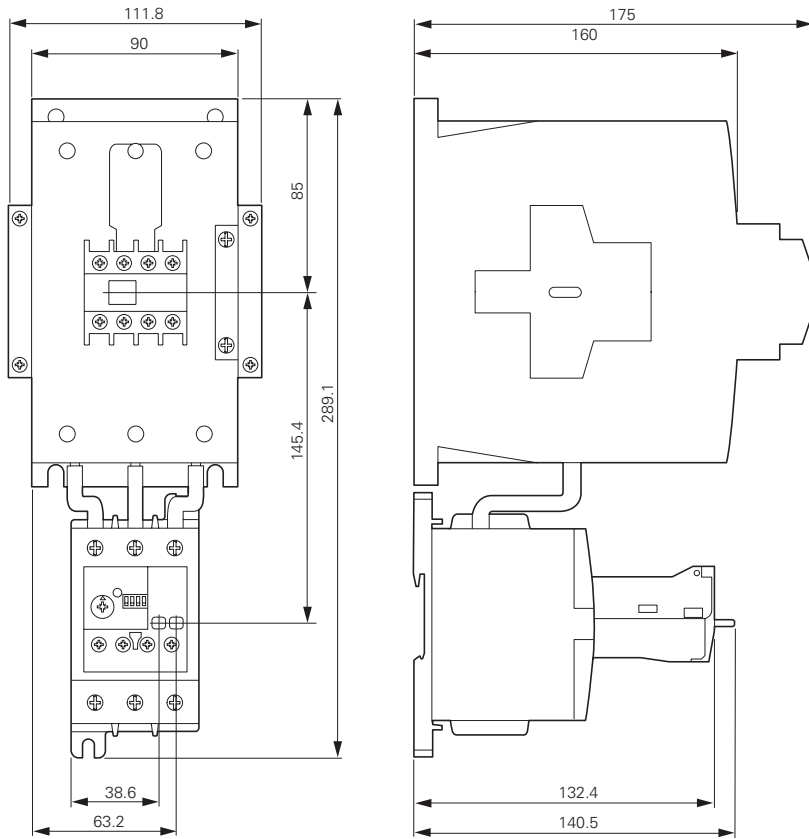

ZEB150-100/KK

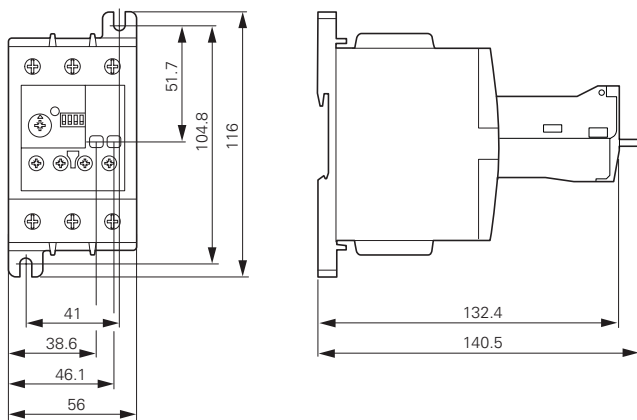

Current sensors

ZEB-XCT300

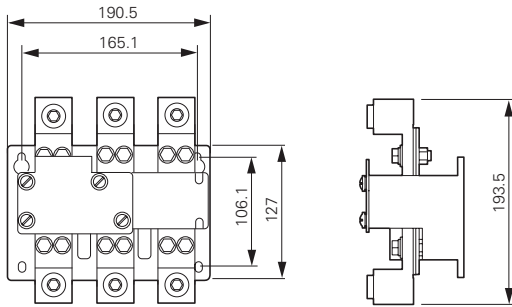

ZEB-XCT600

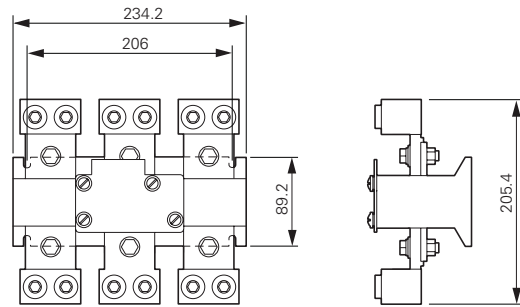

ZEB-XCT1000
ZEB-XCT1500

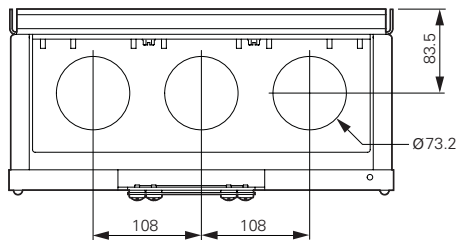
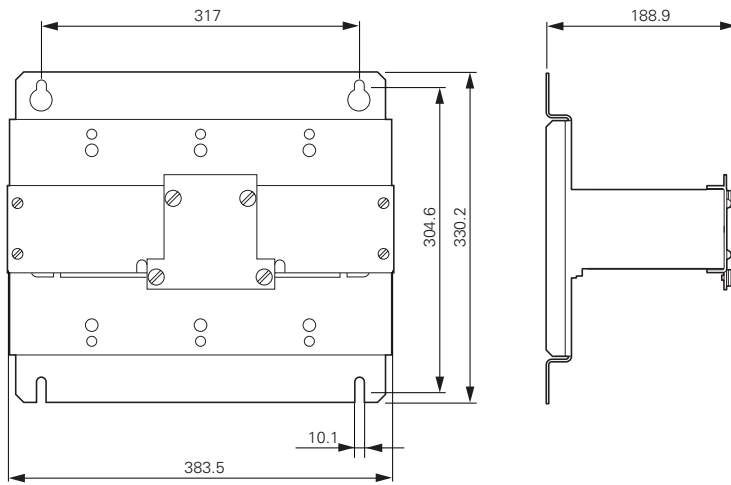

EMT6 thermistor overload relays for machine protection

EMT6...

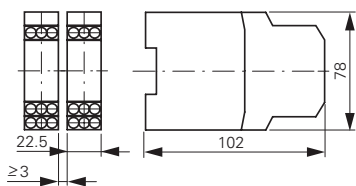

External reset button

M22-DZ-B

M22-DZ-X

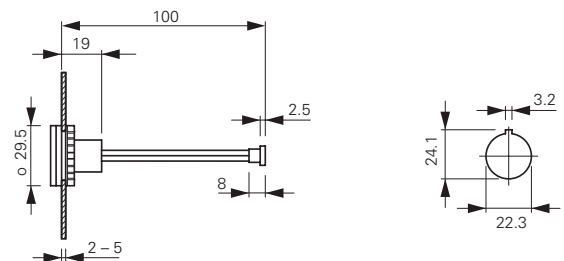

C441 Overload and monitoring relay



Contents

Description

	<i>Page</i>
C441 Overload and monitoring relay	
Features and benefits	45
Catalog number selection	48
Product selection	49
Accessories	50
Technical data and specifications	55
Dimensions	67

C441 Overload and Monitoring Relay

Product Description

Eaton's Motor Insight, the first product in the Intelligent Power Control Solutions family, is a highly configurable motor, load and line protection device with power monitoring, diagnostics and flexible communications allowing the customer to save energy, optimize their maintenance schedules and configure greater system protection, thus reducing overall costs and downtime.

Motor Insight is available in either a line-powered or 120 Vac control powered design, capable of monitoring voltages up to 660 Vac. Each of these units is available in a 1–9 amp or a 5–90 amp FLA model. With external CTs, Motor Insight can protect motors up to 540 amps FLA. Available add-on accessories include communication modules for Modbus RTU, DeviceNet, PROFIBUS, Modbus TCP, EtherNet/IP and HTTP web services all with I/O options. For ease-of-use and operator safety, Motor Insight offers a remote display that mounts easily with two 30 mm knockouts.

Features and Benefits

Features

Size/Range

- Broad FLA range of 1–540A
- Selectable trip class (5–30)
- Four operating voltage options
 - Line-powered from 240 Vac, 480 Vac, 600 Vac
 - Control-powered from 120 Vac

Motor Control

- Two output relays
 - One B300 Form C fault relay and one B300 ground fault shunt relay
 - Other relay configurations are available, including one Form A and one Form B SPST (fault and auxiliary relays) allowing programmable isolated relay behavior and unique voltages
- One external remote reset terminal
- Trip status indicator

Motor Protection

- Thermal overload
- Jam protection
- Current imbalance
- Current phase loss
- Ground fault
- Phase reversal

Load Protection

- Under current
- Low power (kW)
- High power (kW)

Standards and Certifications

- cULus listed NKCR, NKCR7, 508
- UL® 1053 applicable sections for ground fault detection
- CSA® certified (Class 3211-02)
- CE
- NEMA®

Benefits

Reliability and Improved Uptime

- Advanced diagnostics allows for quick and accurate identification of the root source of a motor, pump or power quality fault; reducing trouble-shooting time and the loss of productivity, reducing repeat faults due to misdiagnosis, and increasing process output and profitability
- Provides superior protection of motors and pumps before catastrophic failure occurs
- Increases profitability with greater process uptime and throughput, reduced costs per repair, reduced energy consumption and extended equipment life
- Adjustments to overload configuration can be made at any time

Safety

- IP20 rated terminal blocks
- Terminal blocks are set back from the display to reduce operator shock hazard
- Remote display (optional) does not require that the operator open the panel to configure the device

Flexibility

- Communications modules
 - Offered in a variety of configurations
 - External snap-on modules provide support for multiple communications protocols
- Advanced power, voltage and current monitoring capabilities
- Communications modules and remote display can be used simultaneously
- Highly configurable fault and reset characteristics for numerous applications
- Fully programmable isolated fault and auxiliary relays

Ease of Use

- Bright LED display with easy-to-understand setting and references
- Powered from line voltage or 120 Vac control power
- Remote display powered from base unit
- Full word descriptions and units on user interface

- IEC EN 60947-4-1
- RoHS
- CCC



Advanced Overload Education

Description	Definition	Source	Result	Motor Insight Protection
Motor Protection				
Thermal overload	Overload is a condition in which current draw to a motor exceeds 115% of the full load amperage rating over a period of time for an inductive motor.	<p>An increase in the load or torque that is being driven by the motor.</p> <p>A low voltage supply to the motor would cause the current to go high to maintain the power needed.</p> <p>A poor power factor would cause above normal current draw.</p>	Increase in current draw. Current leads to heat and insulation breakdown, which can cause system failure. Additionally, an increase in current can increase power consumption and waste valuable energy.	<p>Thermal trip behavior is defined by UL, CSA and IEC standards.</p> <p>Trip class is settable from 5–30 by 1</p> <p>Provides power factor monitoring and low voltage protection features.</p>
Jam	Jam is similar to thermal overload in that it is a current draw on the motor above normal operating conditions.	Mechanical stall, interference, jam or seizure of the motor or motor load.	The motor attempts to drive the load, which has more resistive force due to the mechanical interference. In order to drive the load, the motor draws an abnormal amount of current, which can lead to insulation breakdown and system failure.	<p>Provides a configurable Jam setting that is active during “motor run state” to avoid nuisance trips.</p> <p>Trip Threshold 150–400% of FLA.</p> <p>Trip Delay 1–20 seconds.</p>
Ground fault	A line to ground fault.	A current leakage path to ground.	An undetected ground fault can burn through multiple insulation windings, ultimately leading to motor failure.	<p>Motor Insight has ground fault protection capability down to 0.15 amps estimated from the existing three-phase CTs using the residual current method. That is, the three-phase current signals should sum to zero unless a ground fault (GF) condition is present. In the case of a GF, Motor Insight can alarm, trip the starter, or trip an alternative relay that can be used to shunt trip a breaker or light up a warning light. GF current can also be monitored in real-time through the advanced monitoring capabilities.</p> <p>Note: GF settable thresholds vary with motor FLA. 0.15 amps may not be available in all cases.</p>
Imbalanced phases (voltage and current)	Uneven voltage or currents between phases in a three-phase system.	When a three-phase load is powered with a poor quality line, the voltage per phase may be imbalanced.	Imbalanced voltage causes large imbalanced currents and as a result this can lead to motor stator windings being overloaded, causing excessive heating, reduced motor efficiency and reduced insulation life.	Provides two protection settings that address this problem. The user can choose to set current imbalance thresholds or voltage imbalance thresholds, each of which can trip the starter. Additionally, both of these may be monitored through Motor Insight’s advanced monitoring capabilities, allowing the customer to notice in real-time when and where a condition is present.
Phase loss—current (single-phasing)	One of the three-phase current is not present.	Multiple causes, loose wire, improper wiring, grounded phase, open fuse, and so on.	Single-phasing can lead to unwanted motor vibrations in addition to the results of imbalanced phases as listed above.	Fixed protective setting that takes the starter offline if a phase drops below 60% of the other two phases.
Phase rotation (phase-reversal)	Improper wiring, leading to phases being connected to the motor improperly.	A miswired motor. Inadvertent phase-reversal by the utility.	Phase-reversal can cause unwanted directional rotation of a motor. In the event that the load attached to the motor can only be driven in one direction, the result could be significant mechanical failure and/or injury to an operator.	Configurable phase protection, allowing the user to define the phase sequencing intended for that application. If no phase sequence is required, the user has the ability to disable this feature.
Frequency variance	When line frequency is inconsistent.	Malfunctioning alternator speed regulator, or poor line quality caused by an overload of a supply powered by individual sources.	Variations in frequency can cause increases in losses, decreasing the efficiency of the motor. In addition, this can result in interference with synchronous devices.	Advanced monitoring capabilities allow the user to monitor frequency in real-time.

1.2

C441 Overload and monitoring relay

Features and benefits

1

Advanced Overload Education, continued

Description	Definition	Source	Result	Motor Insight Protection
Load Protection				
Under current or low power	Average rms current provided to the motor falls below normal operating conditions.	Under current is usually associated with a portion of the user's load disappearing. Examples of this would be a broken belt, a dry-pump (low suction head) or a dead-headed centrifugal pump.	If under current goes undetected, a mechanical failure can and has occurred. In the case of a pump, running a pump dry or running a pump in a dead-headed condition can cause excessive heating, damaging expensive seals and breaking down desired fluid properties.	Motor Insight has two protection settings to detect this: under current and low power. Low power is a more consistent way of ensuring detection as power is linear with motor load, where as current is not. An unloaded motor may draw 50% of its rated current, but the power draw will be less than 10% of rated power due to a low power factor.
High power	The motor load is drawing more power than it should at normal operating conditions.	This is typical of batch processing applications where several ingredients flow into a mixer. When a substance's consistency changes and viscosity increases from what is expected, the motor may use more power to blend the mixture. Out-of-tolerance conditions can be detected using the High Power and Low Power settings.	If a high-power fault goes undetected, the result may be a batch of material that does not meet specification.	Monitors the three-phase real power. If the real power value is estimated above the set threshold for the set length of time, a fault is detected and the overload will trip the starter. Additionally, power can be monitored in real-time.
Line Protection				
Over voltage	When the line voltage to the motor exceeds the specified rating.	Poor line quality.	An over voltage condition leads to a lower than rated current draw and a poor power factor. A trip limit of 110% of rated voltage is recommended. Over voltage can also lead to exceeding insulation ratings.	Monitors the maximum rms value of the three-phase voltages. If the rms value rises above the set threshold for the set length of time, a fault is detected and the overload can trip the starter or send and display an alarm of the condition. All line-related faults have an "alarm-no-trip" mode.
Under voltage	When the line voltage to the motor is below the specified rating.	Poor line quality.	An under voltage condition leads to excessive current draw. This increases the heating of the motor windings and can shorten insulation life. A trip limit set to 90% of rated voltage is recommended.	Monitors the minimum rms value of the three-phase voltages. If the rms value drops below the set threshold for the set length of time, a fault is detected and the overload can trip the starter or send and display an alarm of the condition. All line-related faults have an "alarm-no-trip" mode.
Power-up delay	Allows for starting motors and loads in a deliberate fashion.	When there is a power failure, or power cycle, multiple loads come online simultaneously.	Multiple loads starting simultaneously can cause sags affecting the operation of devices that may prevent successful startup. If power is lost to a motor driving a pump, it may be necessary to delay a restart to allow the pump to come to a complete stop to prevent starting a motor during backspin.	Configurable to delay closing the fault relay on power-up. For each Motor Insight controlling a motor, a different setting can be programmed, helping to maintain the integrity of your line power.

Catalog Number Selection

1

Motor Insight Overload Relays

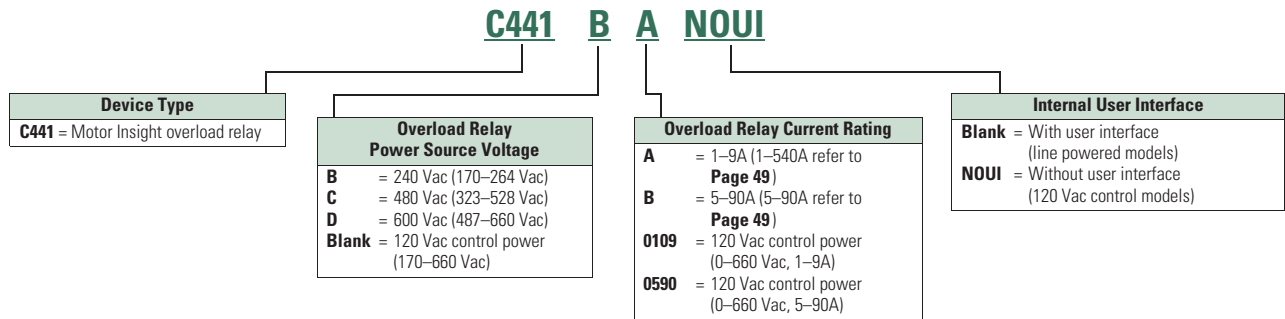

Motor Insight Overload Relays—Communications Modules and Accessory Types

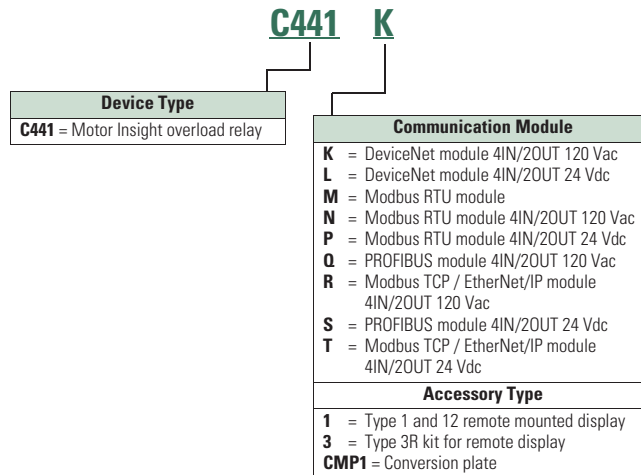

1.2

C441 Overload and monitoring relay

Product Selection

1

Product Selection

Motor Insight



Motor Insight

Power Source	Monitoring Range	Current Range	Catalog Number
240 Vac (170–264)	170–264 Vac	1–9A	C441BA
		5–90A	C441BB
480 Vac (323–528)	323–528 Vac	1–9A	C441CA
		5–90A	C441CB
600 Vac (489–660)	489–660 Vac	1–9A	C441DA
		5–90A	C441DB
120 Vac (93.5–132)	170–660 Vac	1–9A	C4410109NOUI
		5–90A	C4410590NOUI

Motor Insight CT Multiplier and Wire Wrap Schedule

Catalog Number ^①	Motor FLA	Number of Loops	Number of Conductors Through CT Primary	CT Multiplier Setting	External CT Kit Catalog Number ^②
Current Range: 5–90A					
C441_B and C4410590NOUI	5–22.5A	3	4	4	—
	6.67–30A	2	3	3	—
	10–45A	1	2	2	—
	20–90A	0	1	1	—
Current Range: 1–9A					
C441_A and C4410109NOUI	1–5A	1	2	2	—
	2–9A	0	1	1	—
	60–135A	0	1	150–(150:5)	C441CTKIT150
	120–270A	0	1	300–(300:5)	C441CTKIT300
	240–540A	0	1	600–(600:5)	C441CTKIT600

Notes

^① Underscore indicates Operating Voltage Code required.
Operating Voltage Codes:

Code	Voltage
B	240 Vac
C	480 Vac
D	600 Vac
<empty>	120 Vac Control Power

^② Any manufacturer's CTs may be used.

Accessories

Modbus Communication Module

The Motor Insight Modbus Communication Module is a side-mounted device providing Modbus communication capability to the Motor Insight overload relay.

The Modbus Communication Module with I/O provides communication, monitoring and control for the Motor Insight overload relay.

Features and Benefits

- The Modbus communication module is capable of baud rates up to 115K
- The Modbus address and baud rate configuration can be easily changed using the Motor Insight user interface (C441M only)
- Modbus address and baud rate are set via convenient DIP switches (C441N and C441P); LEDs are provided to display Modbus traffic
- Configuration with common Modbus configuration tools
- Terminals
 - Unique locking mechanism provides for easy removal of the terminal block with the field wiring installed
 - Each terminal is marked for ease of wiring and troubleshooting
- Selectable I/O assemblies
 - 4IN/2OUT
 - Signal types include 24 Vdc I/O and 120 Vac I/O
- Each I/O module is optically isolated between the field I/O and the network adapter to protect the I/O and communication circuits from possible damage due to transients and ground loops
- Input Module features a user-definable input debounce, which limits the effects of transients and electrical noise
- Output Module supports a user-definable safe state for loss of communication; hold last state, ON or OFF

Modbus Communication Module

	Description	I/O	Catalog Number
Modbus Module	Modbus Communication Module	None	C441M
Modbus with I/O Module	Modbus Communication Module 4IN/2OUT	120 Vac	C441N
	Modbus Communication Module 4IN/2OUT	24 Vdc	C441P



1.2

C441 Overload and monitoring relay

Accessories

1

DeviceNet Communication Modules

The DeviceNet Communication Module provides monitoring and control for the Motor Insight overload relay from a single DeviceNet node. These modules also offer convenient I/O in two voltage options, 24 Vdc and 120 Vac.

Features and Benefits

- Communication to DeviceNet uses only one DeviceNet MAC ID
- Configuration
 - DeviceNet MAC ID and Baud rate are set via convenient DIP switches with an option to set from the network
 - Advanced configuration available using common DeviceNet tools
- Terminals
 - Unique locking mechanism provides for easy removal of the terminal block with the field wiring installed
 - Each terminal is marked for ease of wiring and troubleshooting
- Selectable I/O assemblies
 - 4IN/2OUT
 - Signal types include 24 Vdc I/O and 120 Vac I/O
 - Each I/O module is optically isolated between the field I/O and the network adapter to protect the I/O and communication circuits from possible damage due to transients and ground loops
- Input Module features a user-definable input debounce, which limits the effects of transients and electrical noise
- Output Module supports a user-definable safe state for loss of communication; hold last state, ON or OFF
- Combined status LED

DeviceNet Module



DeviceNet Modules

Description	I/O	Catalog Number
DeviceNet Communication Module	120 Vac	C441K
DeviceNet Communication Module	24 Vdc	C441L

PROFIBUS Communication Module

The Motor Insight PROFIBUS Communication Module is a side-mounted device providing PROFIBUS communication capability to the Motor Insight overload relay.

The PROFIBUS Communication Module with I/O provides communication, monitoring and control for the Motor Insight overload relay.

Features and Benefits

- The PROFIBUS communication module is capable of baud rates up to 12 Mb
- PROFIBUS address is set via convenient DIP switches (C441Q and C441S); LEDs are provided to display PROFIBUS status
- Intuitive configuration with common PROFIBUS configuration tools
- Terminals
 - Unique locking mechanism provides for easy removal of the terminal block with the field wiring installed
 - Each terminal is marked for ease of wiring and troubleshooting
- Selectable I/O assemblies
 - 4IN/2OUT
 - Signal types include 24 Vdc I/O and 120 Vac I/O
- Each I/O module is optically isolated between the field I/O and the network adapter to protect the I/O and communication circuits from possible damage due to transients and ground loops
- Input Module features a user-definable input debounce, which limits the effects of transients and electrical noise
- Output Module supports a user-definable safe state for loss of communication; hold last state, ON or OFF

PROFIBUS with I/O Module



PROFIBUS Communication Module

Description	I/O	Catalog Number
PROFIBUS Communication Module 4IN/2OUT	120 Vac	C441S
PROFIBUS Communication Module 4IN/2OUT	24 Vdc	C441Q

1.2

C441 Overload and monitoring relay

Accessories

1

Ethernet Communication Module

The Motor Insight Ethernet Communication Module is a side-mounted device providing both Modbus TCP and EtherNet/IP communication capabilities with built-in HTTP web services to the Motor Insight overload relay.

The Ethernet Communication Module with I/O provides communication, monitoring and control for the Motor Insight overload relay.

Features and Benefits

- Supports Modbus TCP or EtherNet/IP in a single device
- Contains internal embedded switch which provides two Ethernet ports allowing linear or ring network configurations
- Embedded web services allow for simple configuration and monitoring through Internet Explorer
- IP Address is set via convenient DIP Switches located on the device
- Terminals
 - Unique locking mechanism provides for easy removal of the terminal block with the field wiring installed
 - Each terminal is marked for ease of wiring and troubleshooting
- Selectable I/O assemblies
 - 4IN/2OUT
 - Signal types include 24 Vdc I/O and 120 Vac I/O
- Each I/O module is optically isolated between the field I/O and the network adapter to protect the I/O and communication circuits from possible damage due to transients and ground loops
- Input Module features a user-definable input debounce, which limits the effects of transients and electrical noise
- Output Module supports a user-definable safe state for loss of communication; hold last state, ON or OFF

Ethernet with I/O Module



Ethernet Communication Module

Description	I/O	Catalog Number
Modbus TCP / EtherNet/IP Communication Module 4IN/2OUT	120 Vac	C441R
Modbus TCP / EtherNet/IP Communication Module 4IN/2OUT	24 Vdc	C441T

Type 3R Kit with Remote Display Mounted Inside



Motor Insight offers several accessories for the customer's ease of use and safety:

- Types 1 and 12 remote display
- Type 3R remote display kit
- Mounting plate adapter

Features and Benefits

- Remote display unit:
 - Same user interface as the overload relay
 - Enhanced operator safety—operator can configure the overload without opening the enclosure door
- Type 3R kit mounts with standard 30 mm holes
- Mounting plate for retrofit in existing installations

Type 3R Kit with Remote Display Mounted Inside

	Description	Catalog Number
C4411	Remote display Types 1 and 12 (UL 508)	C4411
		
C4413	Type 3R kit for remote display (UL 508)	C4413
	Conversion plate (not shown)	C441CMP1

Communication Cables

The Remote Display requires a communication cable to connect to the Motor Insight overload relay:

Communication Cable Lengths

Length in Inches (meters)	Catalog Number
9.8 (0.25)	D77E-QPIP25
39.4 (1.0)	D77E-QPIP100
78.7 (2.0)	D77E-QPIP200
118.1 (3.0)	D77E-QPIP300

Current Transformer Kits

Description	Catalog Number
Three 150:5 CTs to be used with Motor Insight	C441CTKIT150
Three 300:5 CTs to be used with Motor Insight	C441CTKIT300
Three 600:5 CTs to be used with Motor Insight	C441CTKIT600

Technical Data and Specifications

Motor Insight

Description	Specification C441B_	C441C_	C441D_	C441_ _ _ _NOUI		
Electrical Ratings						
Feature	Range					
Operating voltage (three-phase) and frequency	170–264 Vac 50/60 Hz	323–528 Vac 50/60 Hz	489–660 Vac 50/60 Hz	170–660 Vac 50/60 Hz		
Trip Class						
5–30	Selectable	Selectable	Selectable	Selectable		
FLA Range						
C441_A and C4410109NOUI	1–9A	Up to 540A with external CTs Refer to Page 49 for CT multiplier and wire wrap schedule.	Up to 540A with external CTs Refer to Page 49 for CT multiplier and wire wrap schedule.	Up to 540A with external CTs Refer to Page 49 for CT multiplier and wire wrap schedule.		
C441_B and C4410590NOUI	5–90A					
Monitoring Capabilities						
Feature	Value					
Current	Per phase rms (1A, 1B, 1C), 2% accuracy Average rms, 2% accuracy Imbalance percent (0–100%) Ground fault current, 10% accuracy	Per phase rms (1A, 1B, 1C), 2% accuracy Average rms, 2% accuracy Imbalance percent (0–100%) Ground fault current, 10% accuracy	Per phase rms (1A, 1B, 1C), 2% accuracy Average rms, 2% accuracy Imbalance percent (0–100%) Ground fault current, 10% accuracy	Per phase rms (1A, 1B, 1C), 2% accuracy Average rms, 2% accuracy Imbalance percent (0–100%) Ground fault current, 10% accuracy	Per phase rms (1A, 1B, 1C), 2% accuracy Average rms, 2% accuracy Imbalance percent (0–100%) Ground fault current, 10% accuracy	
Voltage	Per phase rms (1A, 1B, 1C), 2% accuracy Average rms, 2% accuracy Imbalance percent (0–100%)	Per phase rms (1A, 1B, 1C), 2% accuracy Average rms, 2% accuracy Imbalance percent (0–100%)	Per phase rms (1A, 1B, 1C), 2% accuracy Average rms, 2% accuracy Imbalance percent (0–100%)	Per phase rms (1A, 1B, 1C), 2% accuracy Average rms, 2% accuracy Imbalance percent (0–100%)	Per phase rms (1A, 1B, 1C), 2% accuracy Average rms, 2% accuracy Imbalance percent (0–100%)	
Power	Motor kW, 5% accuracy Motor power factor, inductive 0–1.0, 1% accuracy	Motor kW, 5% accuracy Motor power factor, inductive 0–1.0, 1% accuracy	Motor kW, 5% accuracy Motor power factor, inductive 0–1.0, 1% accuracy	Motor kW, 5% accuracy Motor power factor, inductive 0–1.0, 1% accuracy	Motor kW, 5% accuracy Motor power factor, inductive 0–1.0, 1% accuracy	
Thermal capacity	0% cold, 100% trip	0% cold, 100% trip	0% cold, 100% trip	0% cold, 100% trip	0% cold, 100% trip	
Motor run hours	0–65,535 hours	0–65,535 hours	0–65,535 hours	0–65,535 hours	0–65,535 hours	
Frequency	47–63 Hz, 1% accuracy	47–63 Hz, 1% accuracy	47–63 Hz, 1% accuracy	47–63 Hz, 1% accuracy	47–63 Hz, 1% accuracy	
Motor Protection						
Thermal overload setting	1.05 x FLA: Does not trip 1.15 x FLA: Overload trip	1.05 x FLA: Does not trip 1.15 x FLA: Overload trip	1.05 x FLA: Does not trip 1.15 x FLA: Overload trip	1.05 x FLA: Does not trip 1.15 x FLA: Overload trip	1.05 x FLA: Does not trip 1.15 x FLA: Overload trip	
Feature	Range				Fault Delay Setting	
Jam	150–400% of motor FLA, OFF	150–400% of motor FLA, OFF	150–400% of motor FLA, OFF	50–400% of motor FLA, OFF	1–20 seconds	
Current imbalance	1–30%, OFF	1–30%, OFF	1–30%, OFF	1–30%, OFF	1–20 seconds	
Current phase loss	Fixed threshold 60%	Fixed threshold 60%	Fixed threshold 60%	Fixed threshold 60%	1–20 seconds	
Ground fault current						
C441_A and C4410109NOUI 1–9A	0.3–2.0A with one pass through the CTs ^①	0.3–2.0A with one pass through the CTs ^①	0.3–2.0A with one pass through the CTs ^①	0.3–2.0A with one pass through the CTs ^①	<150%, 1–60 seconds >150%, 2 seconds >250%, 1 second	
C441_B and C4410590NOUI 5–90A	3.0–20A with one pass through the CTs ^①	3.0–20A with one pass through the CTs ^①	3.0–20A with one pass through the CTs ^①	3.0–20A with one pass through the CTs ^①	<150%, 1–60 seconds >150%, 2 seconds >250%, 1 second	
Phase reversal	OFF = Ignore, 1 = ACB, 2 = ABC	OFF = Ignore, 1 = ACB, 2 = ABC	OFF = Ignore, 1 = ACB, 2 = ABC	OFF = Ignore, 1 = ACB, 2 = ABC		
Fault reset delay	2–500 minutes, auto ^②	2–500 minutes, auto ^②	2–500 minutes, auto ^②	2–500 minutes, auto ^②		
Fault reset attempts	0–4 restarts allowed or automatic reset ^②	0–4 restarts allowed or automatic reset ^②	0–4 restarts allowed or automatic reset ^②	0–4 restarts allowed or automatic reset ^②		

Notes

^① Lower levels are achievable with multiple passes.

^② Motor fault reset characteristics can be programmed as a group or for motor overloads only. Reference the user manual for more detailed information.

Motor Insight, continued

Description	Specification C441B_	C441C_	C441D_	C441_ _ _ _NOUI	
Load Protection					
Feature	Range				Fault Delay Setting
Under current	50–90% of motor FLA	50–90% of motor FLA	50–90% of motor FLA	50–90% of motor FLA	1–60 seconds
Low power (kW)	20–80% of rated kW	20–80% of rated kW	20–80% of rated kW	20–80% of rated kW	1–60 seconds
High power (kW)	50–110% of rated kW	50–110% of rated kW	50–110% of rated kW	50–110% of rated kW	1–60 seconds
Load reset delay	2–500 minutes, auto	2–500 minutes, auto	2–500 minutes, auto	2–500 minutes, auto	
Load reset attempts	0–4, auto	0–4, auto	0–4, auto	0–4, auto	
Supply Protection					
Feature	Range				Fault Delay Setting
Over voltage	170–264 Vac	323–528 Vac	489–660 Vac	0–660 Vac	1–20 seconds
Under voltage	170–264 Vac	323–528 Vac	489–660 Vac	0–660 Vac	1–20 seconds
Voltage imbalance	1–20% imbalance	1–20% imbalance	1–20% imbalance	1–20% imbalance	1–20% imbalance
Restart delay setting	1–500 seconds	1–500 seconds	1–500 seconds	1–500 seconds	1–500 seconds
Electrical/EMC					
Radiated emissions IEC 60947-4-1—Table 15, EN 55011 (CISPR 11) Group 1, Class A	30–1000 mHz	30–1000 mHz	30–1000 mHz	30–1000 mHz	30–1000 mHz
Conducted emissions IEC 60947-4-1—Table 14, EN 55011 (CISPR 11) Group 1, Class A	0.15–30 mHz	0.15–30 mHz	0.15–30 mHz	0.15–30 mHz	0.15–30 mHz
ESD immunity IEC 60947-4-1 (Table 13)	±8 kV air, ±4 kV contact	±8 kV air, ±4 kV contact	±8 kV air, ±4 kV contact	±8 kV air, ±4 kV contact	±8 kV air, ±4 kV contact
Radiated immunity IEC 60947-4-1	10 V/m 80–1000 mHz 80% amplitude modulated 1 kHz sine wave	10 V/m 80–1000 mHz 80% amplitude modulated 1 kHz sine wave	10 V/m 80–1000 mHz 80% amplitude modulated 1 kHz sine wave	10 V/m 80–1000 mHz 80% amplitude modulated 1 kHz sine wave	10 V/m 80–1000 mHz 80% amplitude modulated 1 kHz sine wave
Conducted immunity IEC 60947-4-1	140 dBuV (10V rms) 150 kHz–80 mHz	140 dBuV (10V rms) 150 kHz–80 mHz	140 dBuV (10V rms) 150 kHz–80 mHz	140 dBuV (10V rms) 150 kHz–80 mHz	140 dBuV (10V rms) 150 kHz–80 mHz
Fast transient immunity IEC 60947-4-1 (Table 13) IEC 61000-4-4	±2 kV using direct method	±2 kV using direct method	±2 kV using direct method	±2 kV using direct method	±2 kV using direct method
Surge immunity IEC 60947-4-1 (Table 13) IEC 61000-4-4	Three-phase power inputs: ±2 kV line-to-line (DM) ±4 kV line-to-ground (CM) IEC 61000-4-5 Class 3 User IO and communication lines: ±1 kV line-to-line (DM) ±2 kV line-to-ground (CM)	Three-phase power inputs: ±2 kV line-to-line (DM) ±4 kV line-to-ground (CM) IEC 61000-4-5 Class 3 User IO and communication lines: ±1 kV line-to-line (DM) ±2 kV line-to-ground (CM)	Three-phase power inputs: ±2 kV line-to-line (DM) ±4 kV line-to-ground (CM) IEC 61000-4-5 Class 3 User IO and communication lines: ±1 kV line-to-line (DM) ±2 kV line-to-ground (CM)	Three-phase power inputs: ±2 kV line-to-line (DM) ±4 kV line-to-ground (CM) IEC 61000-4-5 Class 3 User IO and communication lines: ±1 kV line-to-line (DM) ±2 kV line-to-ground (CM)	Three-phase power inputs: ±2 kV line-to-line (DM) ±4 kV line-to-ground (CM) IEC 61000-4-5 Class 3 User IO and communication lines: ±1 kV line-to-line (DM) ±2 kV line-to-ground (CM)
Voltage variations immunity IEC 60947-4-1	30% dip, at 100 ms 60% dip at 10 ms >95% interrupt at 5 ms	30% dip, at 100 ms 60% dip at 10 ms >95% interrupt at 5 ms	30% dip, at 100 ms 60% dip at 10 ms >95% interrupt at 5 ms	30% dip, at 100 ms 60% dip at 10 ms >95% interrupt at 5 ms	30% dip, at 100 ms 60% dip at 10 ms >95% interrupt at 5 ms
Electromagnetic field IEC 60947-4-1 (Table 13) IEC 61000-4-3	10 V/m	10 V/m	10 V/m	10 V/m	10 V/m
Ground fault	UL 508, UL 1053 Sections 21 and 27	UL 508, UL 1053 Sections 21 and 27	UL 508, UL 1053 Sections 21 and 27	UL 508, UL 1053 Sections 21 and 27	UL 508, UL 1053 Sections 21 and 27

1.2

C441 Overload and monitoring relay

Technical data and specifications

1

Motor Insight, continued

Description	Specification C441B_	C441C_	C441D_	C441_ _ _ NOUI
Environmental Ratings				
Feature	Range			
Ambient temperature (operating)	-4° to 122°F (-20° to 50°C)	-4° to 122°F (-20° to 50°C)	-4° to 122°F (-20° to 50°C)	-4° to 122°F (-20° to 50°C)
Ambient temperature (storage)	-40° to 85°C	-40° to 85°C	-40° to 85°C	-40° to 85°C
Operating humidity	5% to 95% noncondensing	5% to 95% noncondensing	5% to 95% noncondensing	5% to 95% noncondensing
Altitude (no derating)	2000m	2000m	2000m	2000m
Shock (IEC 60068-2-27)	15G any direction	15G any direction	15G any direction	15G any direction
Vibration (IEC 60068-2-6)	3G any direction	3G any direction	3G any direction	3G any direction
Pollution degree per IEC 60947-1	3	3	3	3
Ingress protection	IP20	IP20	IP20	IP20
Capacity				
Input, auxiliary contact and external reset terminals				
Terminal capacity	18–12 AWG	18–12 AWG	18–12 AWG	18–12 AWG
Tightening torque	5.3 lb-in (0.6 Nm)	5.3 lb-in (0.6 Nm)	5.3 lb-in (0.6 Nm)	5.3 lb-in (0.6 Nm)
Voltages				
Monitoring voltage	170–264 Vac 50/60Hz	323–528 Vac 50/60Hz	489–660 Vac 60Hz	0–660 Vac 50/60Hz
Insulation voltage U_i (three-phase voltage)	600 Vac	600 Vac	600 Vac	600 Vac
Insulation voltage U_i (control)	240 Vac	240 Vac	240 Vac	240 Vac
Impulse withstand U_{imp} (main/control)	6 kV	6 kV	6 kV	6 kV
Expected Life				
Mechanical/electrical	10 years	10 years	10 years	10 years
Output Contact Ratings				
Two output relays One Form C SPDT (fault relay) One Form A SPST (ground fault relay)	B300 pilot duty 5A thermal continuous current 30A make 3.00A break at 120 Vac and 15A make 1.50A break at 240 Vac	B300 pilot duty 5A thermal continuous current 30A make 3.00A break at 120 Vac and 15A make 1.50A break at 240 Vac	B300 pilot duty 5A thermal continuous current 30A make 3.00A break at 120 Vac and 15A make 1.50A break at 240 Vac	B300 pilot duty 5A thermal continuous current 30A make 3.00A break at 120 Vac and 30A make 1.50A break at 240 Vac ^①
C441_ _ _ NOUI models: One Form A SPST One Form B SPST				
External remote reset terminal	Isolated 120 Vac digital input IEC 61131-2 Section 5 Type 1	Isolated 120 Vac digital input IEC 61131-2 Section 5 Type 1	Isolated 120 Vac digital input IEC 61131-2 Section 5 Type 1	Isolated 120 Vac digital input IEC 61131-2 Section 5 Type 1
Indications				
Trip	Fault	Fault	Fault	Fault
Reset	Ready	Ready	Ready	Ready
Autoreset	Trip faulted/Ready flashing	Trip faulted/Ready flashing	Trip faulted/Ready flashing	Trip faulted/Ready flashing
Power Consumption				
Maximum	5W	5W	5W	5W
Options				
Remote display	Type 1, 12 and Type 3R kit	Type 1, 12 and Type 3R kit	Type 1, 12 and Type 3R kit	Type 1, 12 and Type 3R kit
Communications modules	Modbus, DeviceNet and PROFIBUS with I/O	Modbus, DeviceNet and PROFIBUS with I/O	Modbus, DeviceNet and PROFIBUS with I/O	Modbus, DeviceNet and PROFIBUS with I/O

Note

① In this model, there are two isolated relays: one Form A and one Form B SPST. One is the fault relay, and one is a programmable auxiliary relay.

Motor Insight Short Circuit Ratings (North America CSA and UL)

1

Overload FLA Range	Maximum Operating Voltage	Standard-Fault Short Circuit Data			Maximum Withstand Rating	Maximum Fuse (RK5)	Eaton Thermal-Magnetic Circuit Breaker	Catalog Number
		Withstand Rating	Maximum Fuse (RK5)	Maximum Thermal-Magnetic Circuit Breaker				
1-9A	264 Vac	5000A at 240 Vac	35A	35A	100 kA at 240 Vac	35A	—	C441BA
					100 kA at 240 Vac	—	FDC3035L	
1-9A	528 Vac	5000A at 480 Vac	35A	35A	100 kA at 480 Vac	35A	—	C441CA
					100 kA at 480 Vac	—	FDC3035L	
1-9A	660 Vac	5000A at 600 Vac	35A	35A	100 kA at 600 Vac	35A	—	C441DA
					35 kA at 600 Vac	—	FDC3035L	
1-9A	660 Vac	5000A at 600 Vac	35A	35A	100 kA at 240 Vac	35A	—	C4410109NOUI
					100 kA at 240 Vac	—	FDC3035L	
					100 kA at 480 Vac	35A	—	
					100 kA at 480 Vac	—	FDC3035L	
					100 kA at 600 Vac	35A	—	
5-90A	264 Vac	10,000A at 240 Vac	350A	350A	100 kA at 240 Vac	350A	—	C441BB
					100 kA at 240 Vac	—	KDC3350	
5-90A	528 Vac	10,000A at 480 Vac	350A	350A	100 kA at 480 Vac	350A	—	C441CB
					100 kA at 480 Vac	—	KDC3350	
5-90A	660 Vac	10,000A at 600 Vac	350A	350A	100 kA at 600 Vac	350A	—	C441DB
					65 kA at 600 Vac	—	KDC3350	
5-90A	660 Vac	10,000A at 600 Vac	350A	350A	100 kA at 240 Vac	350A	—	C4410590NOUI
					100 kA at 240 Vac	—	KDC3350	
					100 kA at 480 Vac	350A	—	
					100 kA at 480 Vac	—	KDC3350	
					100 kA at 600 Vac	350A	—	
35 kA at 600 Vac	—	KDC3350						

1.2

C441 Overload and monitoring relay

Technical data and specifications

1

Line Powered Models

Terminal Connection Diagram

Use 75C CU wire only

18–12 AWG; Torque 5.3 lb-in/0.6 Nm
B300 Pilot Duty Only

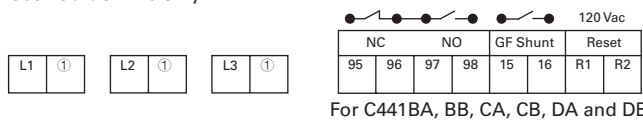

Terminal Connection Specifications

Name	Designation	Input	Description
Line voltage	L1, L2, L3	Line voltage	Three-phase line voltage input L1, L2, L3 connections must correspond to the respective CT1, CT2, CT3 current leads
Fault relay	95/96 96/97 (common) 97/98	B300 UL 508	Form C contact: 95/96 Contact opens when the unit is faulted or unpowered 97/98 Contact closes when the unit is faulted or unpowered
GF shunt	15 16	B300 UL 508	Form A contact: Contact closes when a ground fault is active
Reset input	R1, R2	120 Vac	Fault reset input IEC 61131-2 Type 1

Control Powered Models

Terminal Connection Diagram

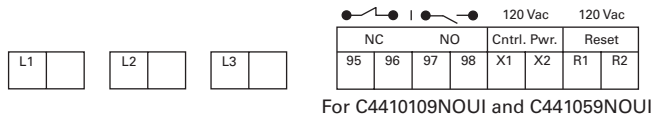

Terminal Connection Specifications

Name	Designation	Input	Description
Line voltage	L1, L2, L3	Line voltage	Three-phase line voltage input L1, L2, L3 connections must correspond to the respective CT1, CT2, CT3 current leads Terminal provided for wiring control power transformer (9A maximum capacity)
Control power	X1, X2	110–120 Vac 50–60Hz (+10/–15%)	Control power option for C441___NOUI
Fault relay For C441___NOUI, the fault relay and auxiliary relay are isolated and do not share a common. By default they will behave like a Form C, but they can be programmed to act independently from one another.	95/96 96/97 (isolated) 97/98	B300 UL 508	Form C contact: 95/96 Contact opens when the unit is faulted or unpowered 97/98 Contact closes when the unit is faulted or unpowered Can be programmed to act independently of the 95/96 only in the C441___NOUI models
GF shunt This relay does not exist on the C441___NOUI models. Instead, this functionality is available in the fully programmable 97/98 auxiliary relay.	97/98	B300 UL 508	Form A contact: Contact closes when a ground fault is active Separate GF control can still be achieved by programming auxiliary relay 97/98 to act independently of the 95/96 relay
Reset input	R1, R2	120 Vac	Fault reset input IEC 61131-2 Type 1

Note

① No motor loads, 9A maximum.

Modbus Communication Modules

Description	Specification	
Electrical/EMC		
Radiated emissions IEC 60947-4-1—Table 15, EN 55011 (CISPR 11) Group 1, Class A	30–1000 mHz	
Conducted emissions IEC 60947-4-1—Table 14, EN 55011 (CISPR 11) Group 1, Class A	0.15–30 mHz	
ESD immunity IEC 60947-4-1 (Table 13) IEC 61000-4-2	±8 kV air, ±4 kV contact	
Radiated immunity IEC 60947-4-1	10 V/m 80–1000 mHz 80% amplitude modulated 1 kHz sine wave	
Conducted immunity IEC 60947-4-1	140 dBuV (10V rms) 150 kHz–80 mHz	
Fast transient immunity IEC 60947-4-1 (Table 13) IEC 61000-4-4	±2 kV using direct method	
Surge immunity IEC 60947-4-1 (Table 13) IEC 61000-4-5 Class 3	User IO and communication lines ^① : ±1 kV line-to-line (DM) ±2 kV line-to-ground (CM)	
Electromagnetic field ¹ IEC 60947-4-1 (Table 13) IEC 61000-4-3	10 V/m	
Environmental Ratings		
Ambient temperature (operating)	–20° to 50°C	
Ambient temperature (storage)	–40° to 85°C	
Operating humidity	5 to 95% noncondensing	
Altitude (no derating)	2000m	
Shock (IEC 60068-2-27)	15G any direction	
Vibration (IEC 60068-2-6)	3G any direction	
Pollution degree per IEC 60947-1	3	
Degree of protection	IP20	
Over voltage category per UL 508	III	
C441P 24 Vdc Input		
Nominal input voltage	24 Vdc	
Operating voltage	18–30 Vdc	
Number of inputs	4	
Signal delay	5 ms (programmable to 65 sec)	
OFF-state voltage	<6 Vdc	
ON-state voltage	>18 Vdc	
Nominal input current	5 mA	
Isolation	1500V	
Terminal screw torque	7–9 in-lb	
24 Vdc source current	50 mA	
Operating Voltage Range—DC Input Modules		
OFF State	Transition Region	ON State
0–6 Vdc	6–18 Vdc	18–30 Vdc
C441N 120 Vac Input		
Nominal input voltage	120 Vac	
Operating voltage	80–140 Vac	
Number of inputs	4	
OFF-state voltage	<30 Vac	
ON-state voltage	>80 Vac	
Nominal input current	15 mA	
Signal delay	1/2 cycle	
Isolation	1500V	
Terminal screw torque	7–9 in-lb	

Note

^① Relates to C441M only.

1.2

C441 Overload and monitoring relay

Technical data and specifications

1

Modbus Communication Modules, continued

Description	Specification	
Operating Voltage Range—AC Input Modules		
OFF State	Transition Region	ON State
0–30 Vac	30–80 Vac	80–140 Vac
Output Modules		
Nominal voltage	120 Vac 24 Vdc	
Number of outputs	(2) 1NO Form A 1NO/NC Form C	
Relay OFF time	3 ms	
Relay ON time	7 ms	
Max. current per point ^①	5A (B300 rated)	
Electrical life	100,000 cycles	
Mechanical life	1,000,000 cycles	

DeviceNet Communication Modules

Description	Specification
Electrical/EMC	
Radiated emissions IEC 60947-4-1—Table 15, EN 55011 (CISPR 11) Group 1, Class A	30–1000 mHz
Conducted emissions IEC 60947-4-1—Table 14, EN 55011 (CISPR 11) Group 1, Class A	0.15–30 mHz
ESD immunity IEC 60947-4-1 (Table 13) IEC 61000-4-2	±8 kV air, ±4 kV contact
Radiated immunity IEC 60947-4-1	10 V/m 80–1000 mHz 80% amplitude modulated 1 kHz sine wave
Conducted immunity IEC 60947-4-1	140 dBuV (10V rms) 150 kHz–80 mHz
Fast transient immunity IEC 60947-4-1 (Table 13) IEC 61000-4-4	±2 kV using direct method
Surge immunity IEC 60947-4-1 (Table 13) IEC 61000-4-5 Class 2	User IO and communication lines: ±1 kV line-to-line (DM) ±2 kV line-to-ground (CM)
Electromagnetic field IEC 60947-4-1 Table 13, IEC 61000-4-3	10 V/m
Environmental Ratings	
Ambient temperature (operating)	–20° to 50°C
Ambient temperature (storage)	–40° to 85°C
Operating humidity	5–95% noncondensing
Altitude (no derating)	2000m
Shock (IEC 60068-2-27)	15G any direction
Vibration (IEC 60068-2-6)	3G any direction
Pollution degree per IEC 60947-1	3
Degree of protection	IP20
DeviceNet	
DeviceNet connections	Group 2, polling, bit strobe, explicit, no UCMM
DeviceNet baud rate	125K, 250K, 500K

Note

^① Resistive current at 55°C ambient.

DeviceNet Communication Modules, continued

Description	Specification
C441L 24 Vdc Input	
Nominal input voltage	24 Vdc
Operating voltage	18–30 Vdc
Number of inputs	4
Signal delay	5 ms (programmable to 65 sec)
OFF-state voltage	<6 Vdc
ON-state voltage	>18 Vdc
Nominal input current	5 mA
Isolation	250V
Terminal screw torque	7–9 in-lb
24V source current	50 mA

Operating Voltage Range—DC Input Modules

OFF State	Transition Region	ON State
0–6 Vdc	6–18 Vdc	18–30 Vdc

C441K 120 Vac Input	
Nominal input voltage	120 Vac
Operating voltage	80–140 Vac
Number of inputs	4
OFF-state voltage	<30 Vac
ON-state voltage	>80 Vac
Nominal input current	15 mA
Signal delay	1/2 cycle
Isolation	250V
Terminal screw torque	7–9 in-lb

Operating Voltage Range—AC Input Modules

OFF State	Transition Region	ON State
0–30 Vac	30–80 Vac	80–140 Vac

Output Modules	
Nominal voltage	120 Vac 24 Vdc
Number of outputs	(2) 1NO Form A 1NO/NC Form C
Relay OFF time	3 ms
Relay ON time	7 ms
Max. current per point ^①	5A (B300 rated)
Electrical life	100,000 cycles
Mechanical life	1,000,000 cycles

Note

^① Resistive current at 55°C ambient.

1.2

C441 Overload and monitoring relay

Technical data and specifications

1

PROFIBUS Communication Modules

Description	Specification
Electrical/EMC	
Radiated emissions IEC 60947-4-1—Table 15, EN 55011 (CISPR 11) Group 1, Class A	30–1000 mHz
Conducted emissions IEC 60947-4-1—Table 14, EN 55011 (CISPR 11) Group 1, Class A	0.15–30 mHz
ESD immunity IEC 60947-4-1 (Table 13) IEC 61000-4-2	±8 kV air, ±4 kV contact
Radiated immunity IEC 60947-4-1 Table 13, IEC 61000-4-3	10 V/m 80–1000 mHz 80% amplitude modulated 1 kHz sine wave
Conducted immunity IEC 60947-4-1	140 dBuV (10V rms) 150 kHz–80 mHz
Fast transient immunity IEC 60947-4-1 (Table 13) IEC 61000-4-4	±2 kV using direct method
Surge immunity IEC 60947-4-1 (Table 13) IEC 61000-4-5 Class 2	User IO and communication lines: ±1 kV line-to-line (DM) ±2 kV line-to-ground (CM)
Environmental Ratings	
Ambient temperature (operating)	–20° to 50°C
Ambient temperature (storage)	–40° to 85°C
Operating humidity	5–95% noncondensing
Altitude (no derating)	2000m
Shock (IEC 60068-2-27)	15G any direction
Vibration (IEC 60068-2-6)	3G any direction
Pollution degree per IEC 60947-1	3
Degree of protection	IP20
PROFIBUS	
PROFIBUS connections	Group 2, polling, bit strobe, explicit, no UCMM
PROFIBUS baud rate	9.6K, 19.2K, 45.45K, 93.75K, 187.5K, 500K, 1.5M, 3M, 6M, 12M
C441Q 24 Vdc Input	
Nominal input voltage	24 Vdc
Operating voltage	18–30 Vdc
Number of inputs	4
Signal delay	5 ms (programmable to 65 sec)
OFF-state voltage	<6 Vdc
ON-state voltage	>10 Vdc
Nominal input current	5 mA
Isolation	1500V
Terminal screw torque	7–9 in-lb
24V source current	50 mA

PROFIBUS Communication Modules, continued

Description	Specification	
Operating Voltage Range—DC Input Modules		
OFF State	Transition Region	ON State
0–6 Vdc	6–18 Vdc	18–30 Vdc
C441S 120 Vac Input		
Nominal input voltage	120 Vac	
Operating voltage	80–140 Vac	
Number of inputs	4	
OFF-state voltage	<20 Vac	
ON-state voltage	>70 Vac	
Nominal input current	15 mA	
Signal delay	1/2 cycle	
Isolation	1500V	
Terminal screw torque	7–9 in-lb	
Operating Voltage Range—AC Input Modules		
OFF State	Transition Region	ON State
0–30 Vac	30–80 Vac	80–140 Vac
Output Modules		
Nominal voltage	120 Vac 24 Vdc	
Number of outputs	(2) 1NO Form A 1NO/NC Form C	
Relay OFF time	3 ms	
Relay ON time	7 ms	
Max. current per point ^①	5A (B300 rated)	
Electrical life	100,000 cycles	
Mechanical life	1,000,000 cycles	

Note

^① Resistive current at 55°C ambient.

1 Ethernet (Modbus TCP / EtherNet/IP) Communication Modules

Description	Specification
Electrical/EMC	
Radiated emissions IEC 60947-4-1, Table 15, EN 55011 (CISPR 11) Group 1, Class A	30–1000 mHz
Conducted emissions IEC 60947-4-1, Table 15, EN 55011 (CISPR 11) Group 1, Class A	0.15–30 mHz
ESD immunity IEC 60947-4-1 (Table 13) IEC 61000-4-2	±8 kV air, ±4 kV contact
Radiated immunity IEC 60947-4-1 (Table 13) IEC 61000-4-3	10 V/m 80–1000 mHz 80% amplitude modulated 1 kHz sine wave
Conducted immunity IEC 60947-4-1	140 dBuV (10V rms) 150 kHz to 80 mHz
Fast transient immunity IEC 60947-4-1 (Table 13) IEC 61000-4-4	±2 kV using direct method
Surge immunity IEC 60947-4-1 (Table 13) IEC 61000-4-5 Class 2	User IO and communication lines: ±1 kV line-to-line (DM) ±2 kV line-to-ground (CM)
Environmental Ratings	
Ambient temperature (operating)	–20° to 50°C
Ambient temperature (storage)	–40° to 85°C
Operating humidity	5–95% noncondensing
Altitude (no derating)	2000m
Shock (IEC 60068-2-27)	15G any direction
Vibration (IEC 60068-2-6)	3G any direction
Pollution degree per IEC 60947-1	3
Degree of protection	IP20
Ethernet	
Ethernet connections	Integrated two-port switch with dual RJ45 Ethernet connections
Ethernet type	Ethernet 10/100 Mbs, AutoMDX, Auto Negotiation
C441T 24 Vdc Input	
Nominal input voltage	24 Vdc
Operating voltage	18–30 Vdc
Number of inputs	4
Signal delay	5 ms (programmable to 65 sec)
OFF-state voltage	<6 Vdc
ON-state voltage	>18 Vdc
Nominal input current	5 mA
Isolation	1500V
Terminal screw torque	7–9 in-lb
24V source current	50 mA

Ethernet (Modbus TCP / EtherNet/IP) Communication Modules, continued

Description	Specification	
Operating Voltage Range—DC Input Modules		
OFF State	Transition Region	ON State
0–6 Vdc	6–18 Vdc	18–30 Vdc
C441R 120 Vac Input		
Nominal input voltage	120 Vac	
Operating voltage	80–140 Vac	
Number of inputs	4	
OFF-state voltage	<30 Vac	
ON-state voltage	>80 Vac	
Nominal input current	15 mA	
Signal delay	1/2 cycle	
Isolation	1500V	
Terminal screw torque	7–9 in-lb	
Operating Voltage Range—AC Input Modules		
OFF State	Transition Region	ON State
0–30 Vac	30–80 Vac	80–140 Vac
Nominal voltage	120 Vac 24 Vdc	
Number of outputs	(2) 1NO Form A 1NO/NC Form C	
Relay OFF time	3 ms	
Relay ON time	7 ms	
Maximum current per point ^①	5A (B300 rated)	
Electrical life	100,000 cycles	
Mechanical life	1,000,000 cycles	

Note

^① Resistive current at 55°C ambient.

1.2 C441 Overload and monitoring relay

Dimensions

1

Dimensions

Approximate Dimensions in mm

Motor Insight Overload Relay

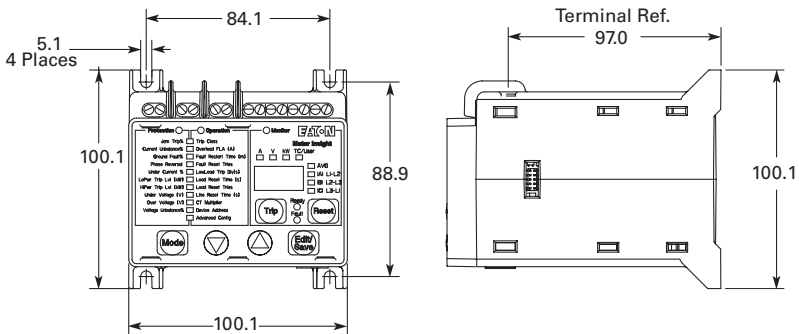

Mounting Dimension
(4) 10-32

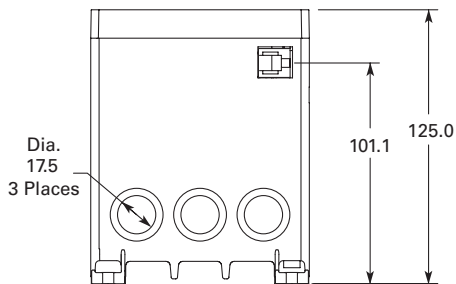

Motor Insight with Mounted DeviceNet, PROFIBUS or Modbus with I/O Communication Module

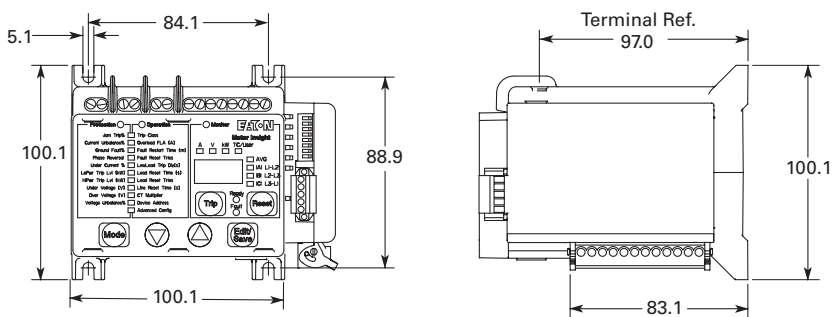

Mounting Dimensions
(4) 10-32

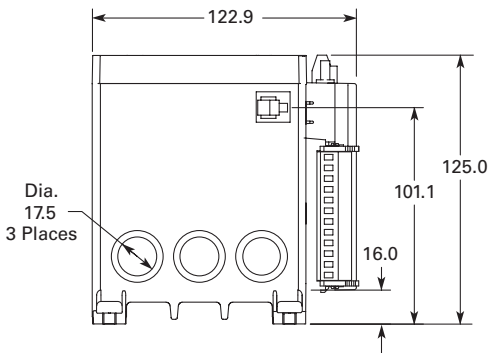

Approximate Dimensions in mm

Motor Insight with Mounted Modbus Communication Module

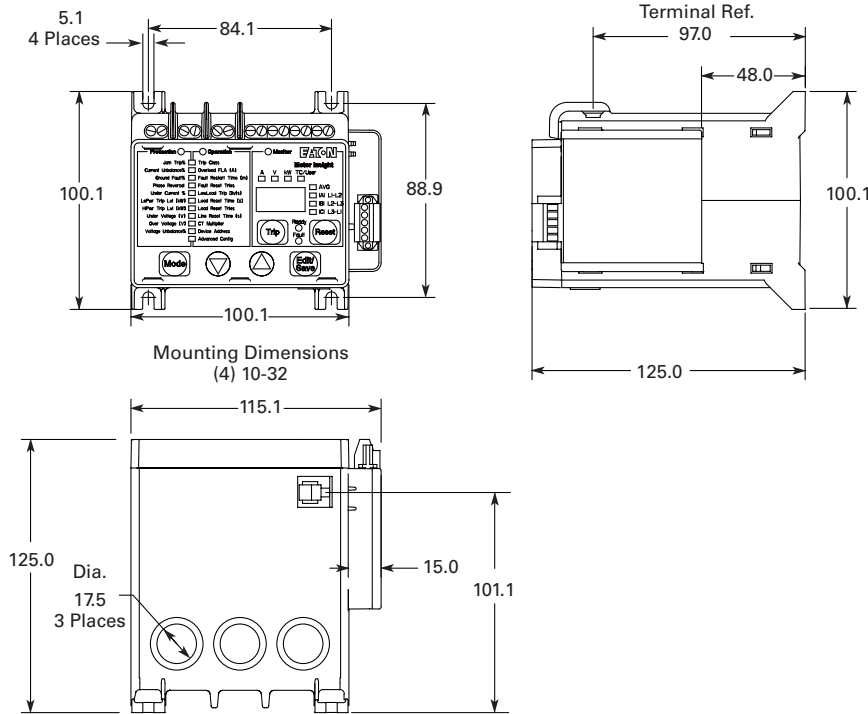

Motor Insight Remote Display

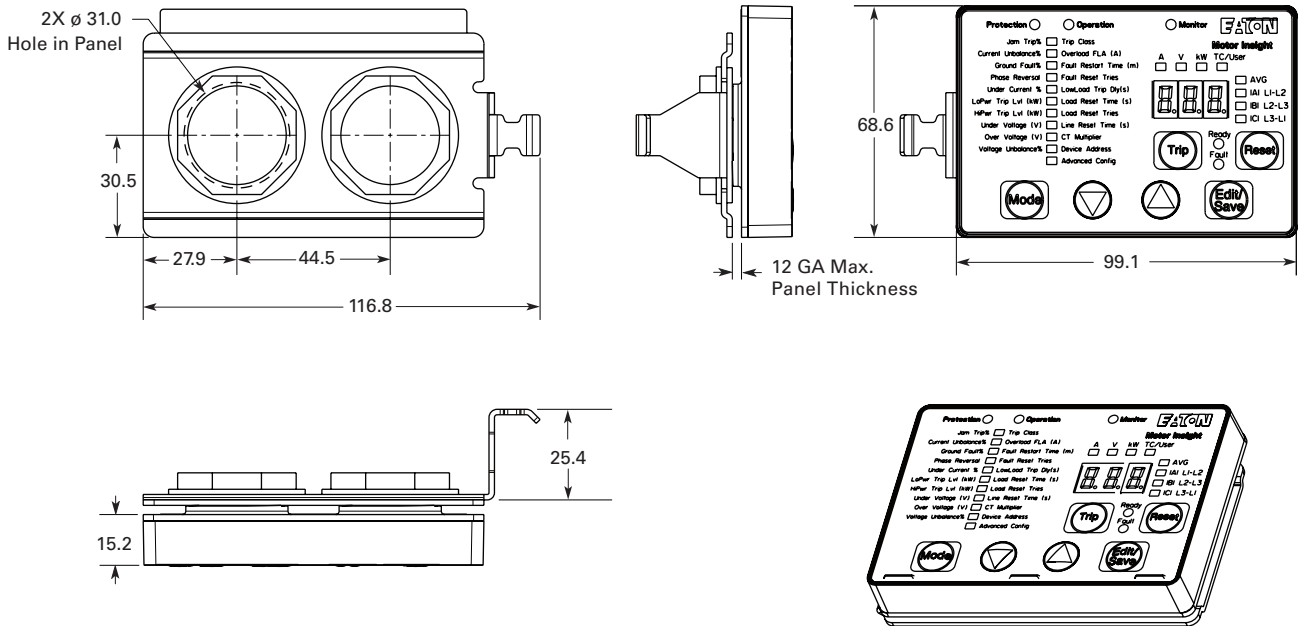

1.2

C441 Overload and monitoring relay

Dimensions

1

Approximate Dimensions in mm

Motor Insight Cover Assembly

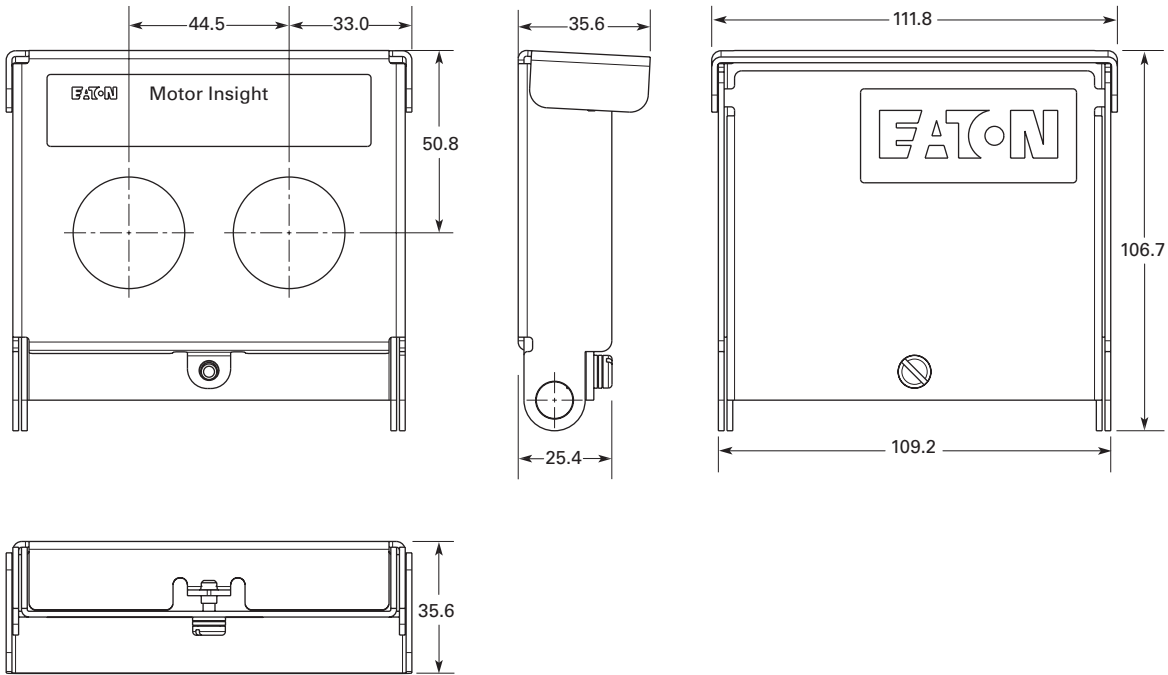

Motor Insight Conversion Plate

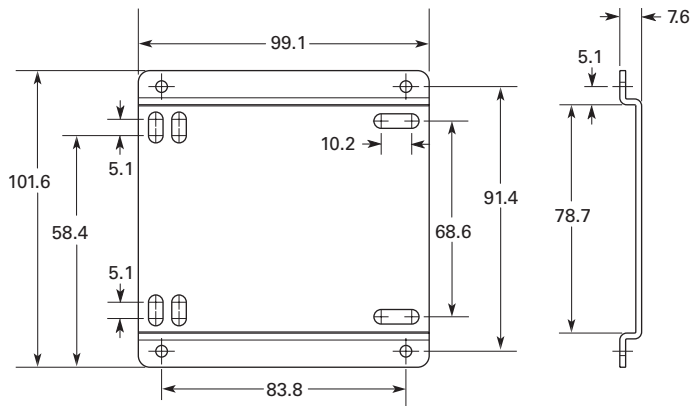

Overload relays ZB..C



Contents

Description

Overload relays ZB..C

	<i>Page</i>
Overload relays ZB..C	71
Accessories	75
Technical data	76
Dimensions	79

- Phase failure sensitivity and temperature compensation
- Reset pushbutton manual/auto
- Test/off pushbutton
- Auxiliary contact (1 N/O + 1 NC)
- Fitted directly on the contactor of the maximum current to 175A

Setting ranges (A)
(note max. current of the contactor)



DILM7..C
DILM9..C
DILM12..C
DILM15..C

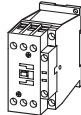

DILM17..C
DILM25..C
DILM32..C
DILM38..C

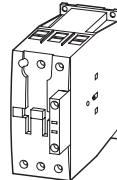

DILM40C
DILM50C
DILM65C
DILM72C

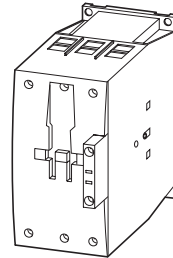

DILM80C
DILM95C
DILM115C
DILM150C
DILM170C

Overload relays

ZB12C

0.1 – 16

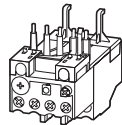

ZB32C

0.1 – 38

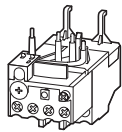

ZB65C

6 – 75

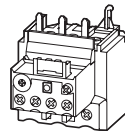

ZB150C

25 – 175

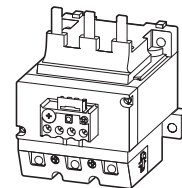

1.3

Overload relays ZB..C

Overload relays

1

Overload relays

Setting range of overload releases	Circuit symbol	Auxiliary contact		For use with	Short-circuit protection	
		N/O = normally open contact N/C = normally closed contact			Type "1" coordination	Type "2" coordination
I_r A					gG/gL A	gG/gL A
0.1 – 0.16		1 N/O	1 N/C	DILM7..C	25	0.5
0.16 – 0.24		1 N/O	1 N/C	DILM9..C	25	1
0.24 – 0.4		1 N/O	1 N/C	DILM12..C	25	2
0.4 – 0.6		1 N/O	1 N/C	DILM15..C	25	4
0.6 – 1		1 N/O	1 N/C		25	4
1 – 1.6		1 N/O	1 N/C		25	6
1.6 – 2.4		1 N/O	1 N/C		25	10
2.4 – 4		1 N/O	1 N/C		25	16
4 – 6		1 N/O	1 N/C		25	20
6 – 10		1 N/O	1 N/C		50	25
9 – 12	1 N/O	1 N/C		50	25	
12 – 16	1 N/O	1 N/C		50	25	
0.1 – 0.16		1 N/O	1 N/C	DILM17..C	25	0.5
0.16 – 0.24		1 N/O	1 N/C	DILM25..C	25	1
0.24 – 0.4		1 N/O	1 N/C	DILM32..C	25	2
0.4 – 0.6		1 N/O	1 N/C	DILM38..C	25	4
0.6 – 0.1		1 N/O	1 N/C		25	4
1 – 1.6		1 N/O	1 N/C		25	6
1.6 – 2.4		1 N/O	1 N/C		25	10
2.4 – 4		1 N/O	1 N/C		25	16
4 – 6		1 N/O	1 N/C		25	20
6 – 10		1 N/O	1 N/C		50	25
10 – 16		1 N/O	1 N/C		63	35
16 – 24		1 N/O	1 N/C		100	35
24 – 32		1 N/O	1 N/C		125	63
32 – 38		1 N/O	1 N/C		125	63

Overload relays ZB12C
Phase failure sensitivity
to IEC/EN 60947
For direct mounting

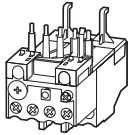

Overload relays ZB32C
Phase failure sensitivity
to IEC/EN 60947
For direct mounting

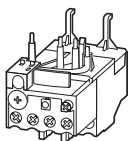

Part no. Std. pack
Article no.

Notes

ZB12C-0,16 115080	1 Off	Overload release: tripping class 10A Short-circuit protection: With direct mounting, observe the maximum permissible fuse of the contactor.
ZB12C-0,24 115081	1 Off	
ZB12C-0,4 115082	1 Off	
ZB12C-0,6 115083	1 Off	
ZB12C-1 115084	1 Off	
ZB12C-1,6 115085	1 Off	
ZB12C-2,4 115086	1 Off	
ZB12C-4 115087	1 Off	
ZB12C-6 115088	1 Off	
ZB12C-10 115089	1 Off	
ZB12C-12 115090	1 Off	
ZB12C-16 115091	1 Off	
ZB32C-0,16 115092	1 Off	
ZB32C-0,24 115093	1 Off	
ZB32C-0,4 115094	1 Off	
ZB32C-0,6 115095	1 Off	
ZB32C-1 115096	1 Off	
ZB32C-1,6 115097	1 Off	
ZB32C-2,4 115098	1 Off	
ZB32C-4 115099	1 Off	
ZB32C-6 115100	1 Off	
ZB32C-10 115101	1 Off	
ZB32C-16 115102	1 Off	
ZB32C-24 115103	1 Off	
ZB32C-32 115104	1 Off	
ZB32C-38 115105	1 Off	

Fitted directly to the contactor

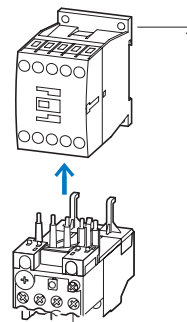

1 Contactor

→ See Contactor Catalog

Fitted directly to the contactor

Separate mounting

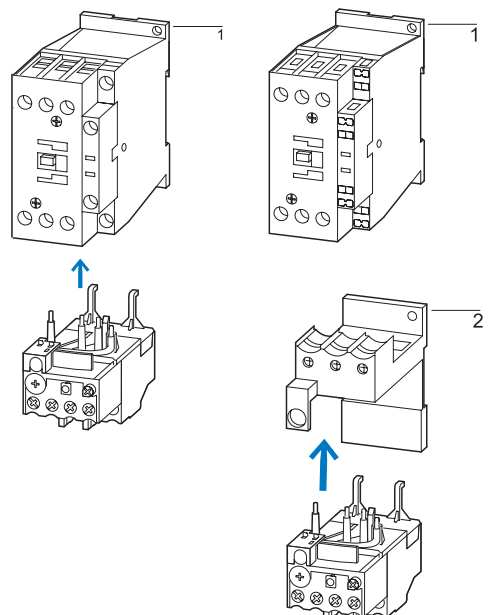

1 Contactor

2 Base

→ See Contactor Catalog

→ 75

1.3

Overload relays ZB..C

Overload relays

1

Overload relays

Setting range of
overload
releases

Circuit symbol

Auxiliary contact

For use with

Short-circuit protection

N/O = normally open contact
N/C = normally closed contact

Type "1"
coordination

Type "2"
coordination

I_r
A

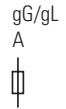
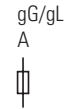

Overload relays ZB65C
Phase failure sensitivity
to IEC/EN 60947
For direct mounting

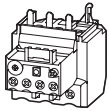

6 – 10

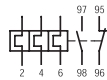

1 N/O

1 N/C

DILM40C
DILM50C
DILM65C
DILM72C

50

25

10 – 16

1 N/O

1 N/C

63

35

16 – 24

1 N/O

1 N/C

63

50

24 – 40

1 N/O

1 N/C

125

63

40 – 57

1 N/O

1 N/C

160

80

50 – 65

1 N/O

1 N/C

160

100

60 – 75

1 N/O

1 N/C

250

160

Overload relays ZB150C
Phase failure sensitivity
to IEC/EN 60947
For direct mounting

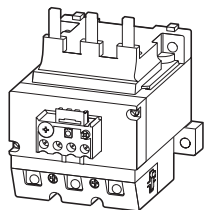

25 – 35

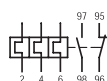

1 N/O

1 N/C

DILM80C
DILM95C
DILM115C
DILM150C
DILM170C

125

100

35 – 50

1 N/O

1 N/C

160

125

50 – 70

1 N/O

1 N/C

250

160

70 – 100

1 N/O

1 N/C

315

200

95 – 125

1 N/O

1 N/C

315

250

120 – 142

1 N/O

1 N/C

315

250

145 – 175

1 N/O

1 N/C

315

250

Part no.
Article no.

Std. pack

Notes

ZB65C-10 105702	1 Off	Overload release: tripping class 10A Short-circuit protection: With direct mounting, observe the maximum permissible fuse of the contactor.
ZB65C-16 105703	1 Off	
ZB65C-24 105704	1 Off	
ZB65C-40 105705	1 Off	
ZB65C-57 105706	1 Off	
ZB65C-65 105707	1 Off	
ZB65C-75 112114	1 Off	

Fitted directly to the contactor Separate mounting

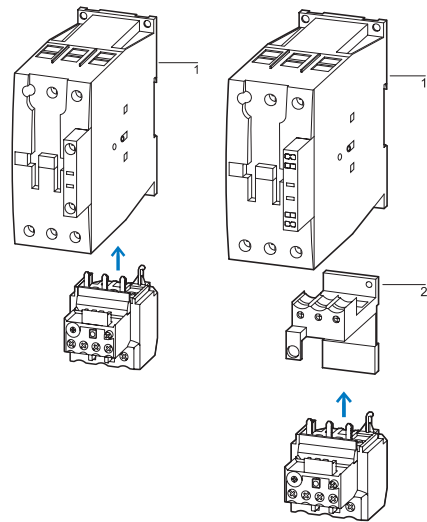

1 Contactor
2 Base

→ See Contactor Catalog
→ 75

ZB150C-35 105708	1 Off	Overload release: tripping class 10A Short-circuit protection: With direct mounting, observe the maximum permissible fuse of the contactor.
ZB150C-50 105709	1 Off	
ZB150C-70 105710	1 Off	
ZB150C-100 105711	1 Off	
ZB150C-125 105712	1 Off	
ZB150C-150 105713	1 Off	
ZB150C-175 112113	1 Off	

Fitted directly to the contactor

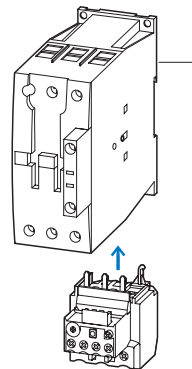

1 Contactor

→ See Contactor Catalog

1.3

Overload relays ZB..C

Accessories

1

For separate mounting



Bases

For use with	Part no. Article no.	Std. pack	Notes
ZB32C	ZB32-XEZ 278473	5 Off	Can be snap fitted on a top-hat rail to IEC/EN 60715 or can be screw fitted.
ZB65C	ZB65-XEZ 278474	1 Off	Can be snap fitted on a top-hat rail to IEC/EN 60715 or can be screw fitted.

Pushbuttons

For enclosed overload relays
Mounting diameter: 22.3 mm

For use with	Part no. Article no.	Std. pack	Notes
ZB12C	M22-DZ-B 254833	10 Off	Button plate, blue
ZB32C	M22-DZ-B-GB14 254834	10 Off	Button plate, blue RESET
ZB65C	M22-DZ-X 254835	10 Off	Without button plate, add button plate.
ZB150C			
M22-DZ-X	M22-XD-R 216423	10 Off	Button plate, red
	M22-XD-R-X0 218153	10 Off	Button plate, red with white circle
	M22-XD-R-GB0 218194	10 Off	Button plate, red STOP

External reset button, IP65



Off button, IP65



Button plates

—

Selection criteria

	ZB12C, ZB32C, ZB65C, ZB150C
Phase failure sensitivity	●
Temperature compensation	●
Auxiliary contact 1N/O + 1N/C	●
Test/Release pushbutton	●
Reset pushbutton manual/auto	●
Separate mounting	●
Explosion-proof motor protection (PTB)	—
Protection with heavy starting duty	—
Trip-free	●

Protection of single-phase and DC current motors:

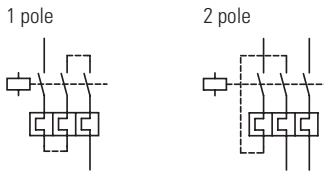

Mounting position:

ZB12C, ZB32C, ZB65C, ZB150C

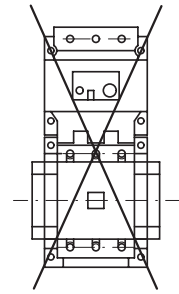

These tripping characteristics are mean values of the spread at 20 °C ambient temperature in a cold state. They show the tripping times in relation to the response current.

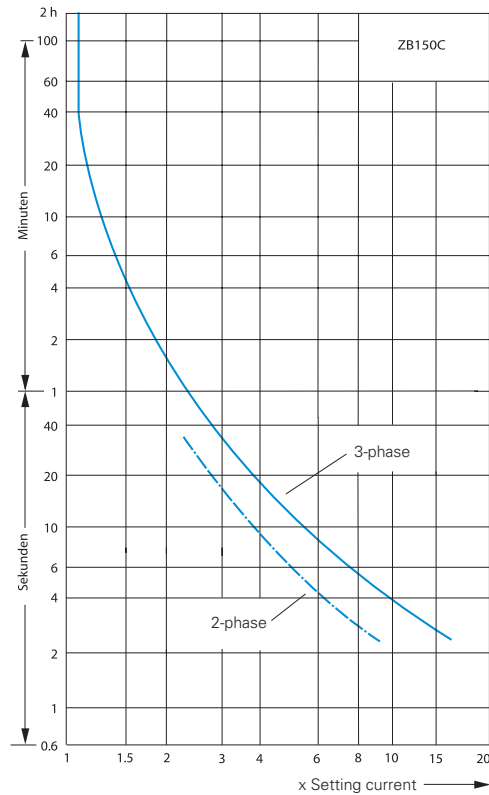
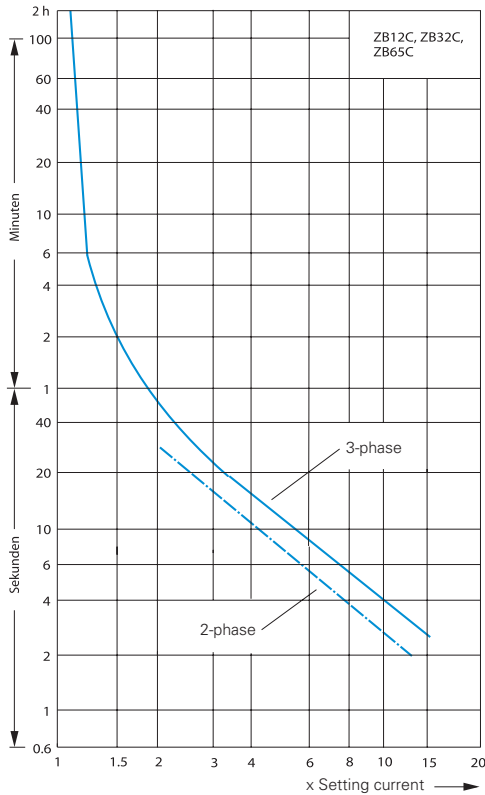

1.3

Overload relays ZB..C

Technical data

1

Technical data

			ZB12C	ZB32C	ZB65C	ZB150C
General						
Standards	IEC/EN 60947, VDE 0660, GB 14048					
Climatic proofing	Damp heat, constant, to IEC 60068-2-78; Damp heat, cyclic, to IEC 60068-2-30					
Ambient temperature						
Open ¹⁾	°C		-25...55	-25...55	-25...55	-25...55
Enclosed ¹⁾	°C		-25...40	-25...40	-25...40	-25...40
Temperature compensation			Continuous	Continuous		
Mounting position			→ Page 76	→ Page 76	→ Page 76	→ Page 76
Weight	kg		0.15	0.15	0.25	1.64
Mechanical shock resistance half-sinusoidal shock, 10 ms	g		10	10	10	10
Protection type			IP20	IP20	IP00	IP00
Protection against direct contact when actuated from front (EN 50274)			Finger- and back-of-hand proof			
Main contacts						
Rated impulse withstand voltage	U_{imp}	V AC	6000	6000	6000	6000
Overtoltage category/pollution degree			III/3	III/3	III/3	III/3
Rated insulation voltage						
AC	U_i	V AC	690	690	690	690
Rated operating voltage	U_e	V AC	690	690	690	690
Safe isolation according to EN 61140						
Between auxiliary contacts and main contacts	V AC		440	440	440	440
Between the main contacts	V AC		440	440	440	440
Overload relay setting range	A		0.1 – 16	0.1 – 38	6 – 75	25 – 150
Temperature compensation residual error > 40 °C	% / K		≤ 0.25	≤ 0.25	≤ 0.25	≤ 0.25
Short-circuit protection rating maximum fuse			→ Page 71	→ Page 71	→ Page 73	→ Page 73
Current heat loss (3 conductors)						
Lower value of setting range	W		2.5	2.5	3	16
Upper value of setting range	W		6	6	7.5	28
Terminal capacity						
Solid	mm ²		2 × (0.75 – 2.5)	2 × (1 – 6)	2 × (1 – 16) ⁴⁾	2 × (4 – 16)
Flexible with ferrule	mm ²		2 × (0.5 – 1.5)	2 × (1 – 4) 2 × (1 – 6) ³⁾	1 × (1 – 25) 2 × (1 – 10) ²⁾	1 × (4 – 70) 2 × (4 – 50)
Stranded	mm ²		–	–	1 × (16 – 25)	1 × (16 – 50) 2 × (16 – 50)
Solid or stranded	AWG		18 – 14	14 – 8	14 – 2	2/0
Terminal screw			M3.5	M4	M6	M10
Tightening torque	Nm		2	1.8	3.5	10
Tools						
Pozidriv screwdriver	Size		2	2	2	–
Flat-blade screwdriver	mm		0.8 × 5.5	1 × 6	1 × 6	–
Hexagon socket	SW	mm	–	–	–	5

- Notes**
- 1) Ambient temperature: Operating range to IEC/EN 60947
 - 2) Use identical cross-section when using two conductors
 - 3) 6 mm flexible with ferrules to DIN 46228
 - 4) With ZB65-XEZ max 1 x (1... 16)

Technical data

1

			ZB12C, ZB32C	ZB65C	ZB150C
Auxiliary and control circuits					
Rated impulse withstand voltage	U_{imp}	V	6000	6000	6000
Overvoltage category/Pollution degree			III/3	III/3	III/3
Terminal capacity					
Solid		mm ²	2 × (0.75 – 4)	2 × (0.75 – 4)	2 × (0.75 – 4)
Flexible with ferrule		mm ²	2 × (0.75 – 2.5)	2 × (0.75 – 2.5)	2 × (0.75 – 2.5)
Solid or stranded		AWG	18 – 12	18 – 12	18 – 12
Terminal screw			M3.5	M3.5	M3.5
Tightening torque		Nm	0.8 – 1.2	0.8 – 1.2	0.8 – 1.2
Tools					
Pozidriv screwdriver		Size	2	2	2
Flat-blade screwdriver		mm	1 × 6	1 × 6	1 × 6
Rated insulation voltage	U_i	V AC	500	500	500
Rated operating voltage	U_e	V AC	500	500	500
Safe isolation according to EN 61140					
Between the auxiliary contacts		V AC	240	240	240
Conventional thermal current	I_{th}	A	6	6	6
Rated operational current					
AC-15					
N/O					
120 V	I_e	A	1.5	1.5	1.5
240 V	I_e	A	1.5	1.5	1.5
415 V	I_e	A	0.5	0.5	0.5
500 V	I_e	A	0.5	0.5	0.5
N/C					
120 V	I_e	A	1.5	1.5	1.5
240 V	I_e	A	1.5	1.5	1.5
415 V	I_e	A	0.9	0.9	0.9
500 V	I_e	A	0.8	0.8	0.8
DC-13 L/R ≤ 15 ms ¹⁾					
24 V	I_e	A	0.9	0.9	0.9
60 V	I_e	A	0.75 ³⁾	0.75 ³⁾	0.75 ³⁾
110 V	I_e	A	0.4	0.4	0.4
220 V	I_e	A	0.2	0.2	0.2
Short-circuit rating without welding					
Max. fuse ²⁾		A gG/gL	6	6	6

- Notes**
- 1) Making and breaking conditions to DC-13, time constant as stated
 - 2) See transparent overlay "Fuses" for time/current characteristics (please enquire)
 - 3) Rated operational current DC-13, 60 V: N/O auxiliary contact 0.6 A

1.3

Overload relays ZB..C

Dimensions

1 Overload relays

ZB12C

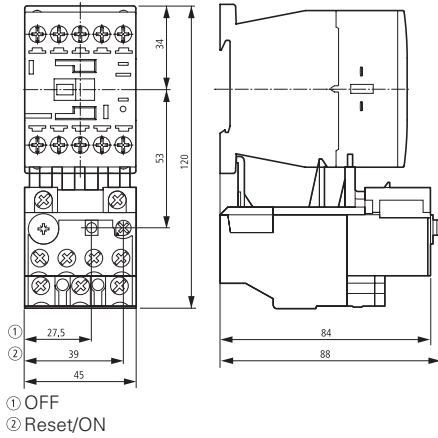

ZB32C

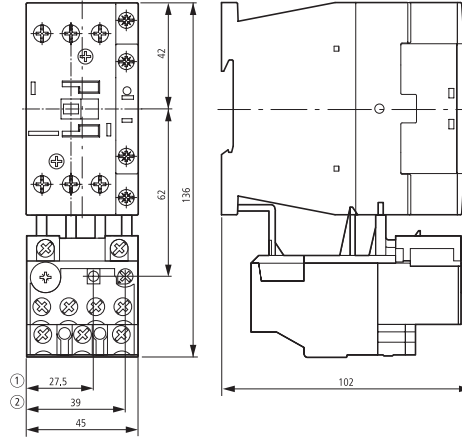

ZB65C

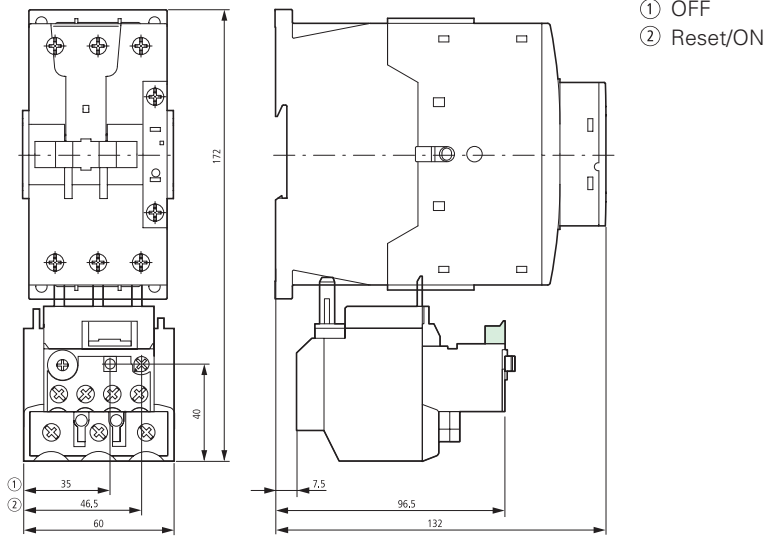

Base ZB32-XEZ/ZB65-XEZ

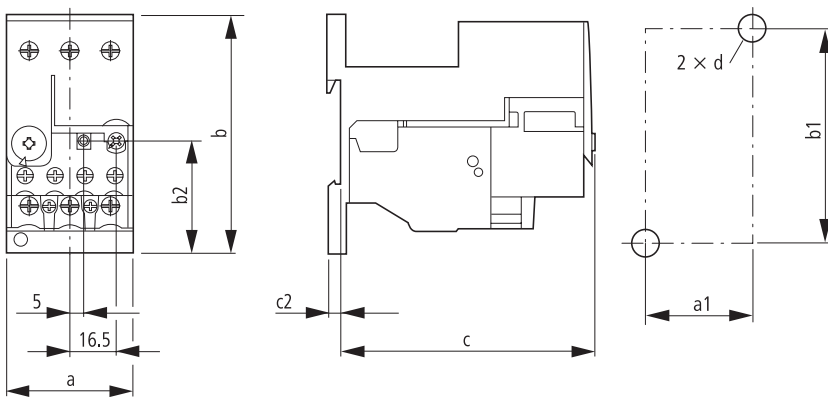

	ZB32	ZB65
a	45	60
b	85	86
c	90.5	112
c2	3.8	4.7
a1	35	50
b1	75	75
b2	40.5	47
d	M4	M5

Overload relays

ZB150C

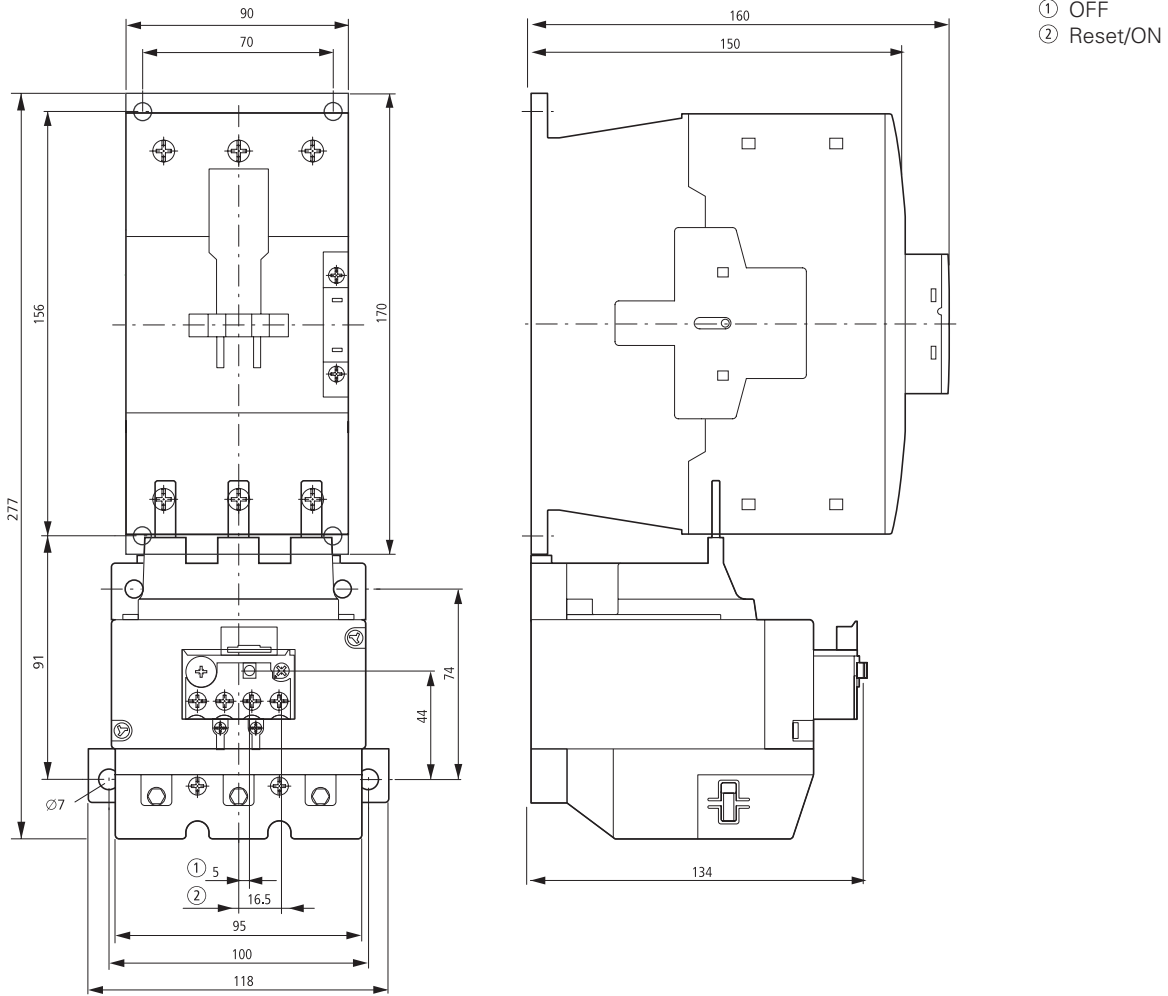

M22-DZ...External reset button OFF Pushbutton M22-DZ...

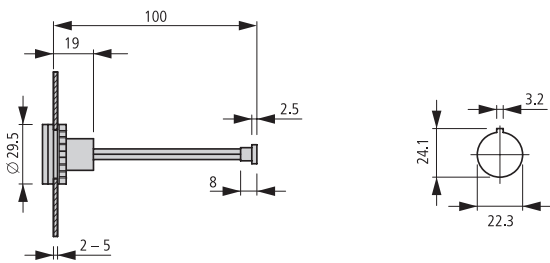

Thermal overload relays XTOD



Contents

Description

Thermal overload relays XTOD

	Page
System overview	82
Thermal overload relays	83
Accessory	87
Engineering data	88
Technical data	89
Dimensions	90

Thermal overload relays XTOD

Product Description

- 5 frames with current ranges up to 85A
- 1NO & 1NC auxiliary contact as standard
- Phase-loss protection available
- Selectable auto/manual reset
- Direct or panel mount

Standards and Certifications

- IEC/EN 60947
- CE
- UL/CSA (pending for availability)

System overview

Thermal overload relays

Setting range(A)
(Note the maximum current of contactor)

	XTC007~016	XTC022~026 XTC032	XTC038	XTC040	XTC055~085
XTOD..CC1 0.3-30					
XTOD..DC1 17-32					
XTOD..EC1 17-40					
XTOD..FC1 17-40					
XTOD..GC1 17-97					

1.4











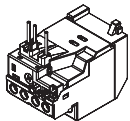









Thermal overload relays XTOD

Thermal overload relays

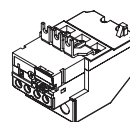
1

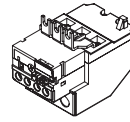
Thermal overload relays

Thermal overload relays

For use with			Setting range of overload releases I_r (A)	Circuit symbol	Auxiliary contact	Part no. Article no.	Standard package
XTOD..CC1 	XTCD007	Direct mounting	0.3~0.45		1 N/O 1 N/C	XTODP45CC1 152479	1 piece
	XTCD009	Direct mounting	0.45 ~0.67		1 N/O 1 N/C	XTODP67CC1 152480	1 piece
	XTCD012	Direct mounting	0.67~1.0		1 N/O 1 N/C	XTOD001CC1 152481	1 piece
	XTCD016	Direct mounting	1.0 ~1.5		1 N/O 1 N/C	XTOD1P5CC1 152482	1 piece
	XTCD022	Direct mounting	1.4 ~2.1		1 N/O 1 N/C	XTOD2P2CC1 152483	1 piece
	XTCD026	Direct mounting	1.8~2.7		1 N/O 1 N/C	XTOD2P7CC1 152484	1 piece
	XTCD032	Direct mounting	2.4~3.6		1 N/O 1 N/C	XTOD3P6CC1 152485	1 piece
		Direct mounting	3.5~5.0		1 N/O 1 N/C	XTOD005CC1 152486	1 piece
		Direct mounting	4.0~6.0		1 N/O 1 N/C	XTOD006CC1 152487	1 piece
		Direct mounting	5.5~8.5		1 N/O 1 N/C	XTOD8P5CC1 152488	1 piece
		Direct mounting	8.5~12.5		1 N/O 1 N/C	XTOD013CC1 152489	1 piece
		Direct mounting	12.5~18		1 N/O 1 N/C	XTOD018CC1 152490	1 piece
		Direct mounting	17~24		1 N/O 1 N/C	XTOD024CC1 152491	1 piece
		Direct mounting	22~30		1 N/O 1 N/C	XTOD030CC1 152492	1 piece
	XTOD..DC1 	XTCD022	Direct mounting	17~25		1 N/O 1 N/C	XTOD025DC1 152493
XTCD026		Direct mounting	23~32		1 N/O 1 N/C	XTOD032DC1 152494	1 piece
XTCD032		Direct mounting					
XTOD..EC1 	XTCD038	Direct mounting	17~25		1 N/O 1 N/C	XTOD025EC1 152495	1 piece
	XTCD038	Direct mounting	23~32		1 N/O 1 N/C	XTOD032EC1 152496	1 piece
	XTCD038	Direct mounting	30~40		1 N/O 1 N/C	XTOD040EC1 152497	1 piece

Overload release: tripping class 10A

Notes

Fit to the contactor directly

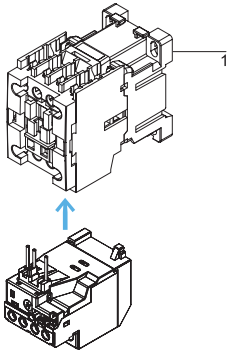

Separate Mounting

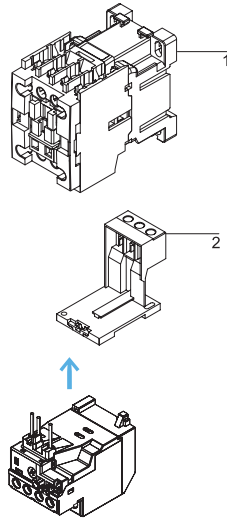

Page

- 1 Contactor → See Contactor Catalog
- 2 Mounting Adapter → 87

Fit to the contactor directly

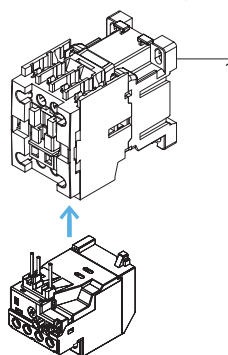

Page

- 1 Contactor → See Contactor Catalog











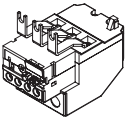



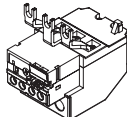

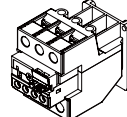

1.4

Thermal overload relays XTOD

Thermal overload relays

1

Thermal overload relays

For use with		Setting range of overload releases I_r (A)	Circuit symbol	Auxiliary contact		Part no. Article no.	Standard package
				N/O =Normally open	N/C =Normally closed		
XTOD..FC1 	XTCD040	Direct mounting	17-25		1 N/O 1 N/C	XTOD025FC1 152498	1 piece
		Direct mounting	23-32		1 N/O 1 N/C	XTOD032FC1 152499	1 piece
		Direct mounting	30-40		1 N/O 1 N/C	XTOD040FC1 152500	1 piece
XTOD..GC1 	XTCD055	Direct mounting	17-25		1 N/O 1 N/C	XTOD025GC1 152501	1 piece
	XTCD065	Direct mounting	23-32		1 N/O 1 N/C	XTOD032GC1 152502	1 piece
	XTCD072	Direct mounting	30-40		1 N/O 1 N/C	XTOD040GC1 152503	1 piece
	XTCD085	Direct mounting	37-50		1 N/O 1 N/C	XTOD050GC1 152504	1 piece
		Direct mounting	48-65		1 N/O 1 N/C	XTOD065GC1 152505	1 piece
		Direct mounting	63-80		1 N/O 1 N/C	XTOD080GC1 152506	1 piece
		Direct mounting	77-97		1 N/O 1 N/C	XTOD097GC1 152507	1 piece
	XTOD..GC1S 	XTCD025	Direct mounting	17-25		1 N/O 1 N/C	XTOD025GC1S 152508
XTCD032		Direct mounting	23-32		1 N/O 1 N/C	XTOD032GC1S 152509	1 piece
XTCD038		Direct mounting	30-40		1 N/O 1 N/C	XTOD040GC1S 152510	1 piece
XTCD040		Direct mounting	37-50		1 N/O 1 N/C	XTOD050GC1S 152511	1 piece
XTCD055		Direct mounting	48-65		1 N/O 1 N/C	XTOD065GC1S 152512	1 piece
XTCD065		Direct mounting	63-80		1 N/O 1 N/C	XTOD080GC1S 152513	1 piece
XTCD072		Direct mounting	77-97		1 N/O 1 N/C	XTOD097GC1S 152514	1 piece
XTCD085		Direct mounting					
		Direct mounting					

Overload release: tripping class 10A

Notes

Fit to the contactor directly

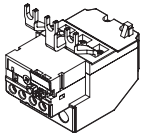
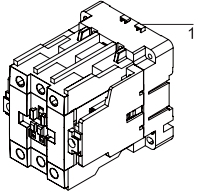

Page

1 Contactor

→ See Contactor Catalog

Fit to the contactor directly

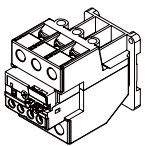
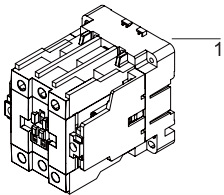

Page

1 Contactor

→ See Contactor Catalog

1.4

Thermal overload relays XTOD

Accessory

1

Accessory

Panel mounting adapter

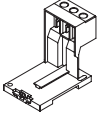

Accessory

	For use with	Part no. Article no.	Standard package
For separate mounting	XTOD..CC1	XTODXDINC 152515	1 piece

Can be snap fitted on a DIN rail to IEC/EN 60715 or can be screw fitted.

Engineering data

Engineering data

Items	XTOD
Phase-loss sensitivity	•
Temperature compensation	•
Auxiliary contact N/O+N/C	•
Test / release button	•
Reset button Manual/Auto	•
Separate mounting	•

Protection of single-phase:

1 pole

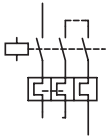

2 pole

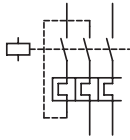

Mounting position:

XTOD

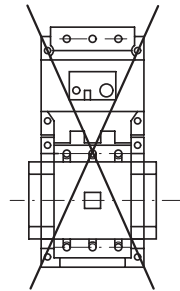

1.4

Thermal overload relays XTOD

Technical data

1

Technical data

General

		XTOD..CC1	XTOD..DC1	XTOD..EC1	XTOD..FC1	XTOD..GC1
Standards		IEC/EN 60947, GB 14048				
Climatic Proofing		Damp heat, constant, to IEC60068-2-78 Damp heat, cyclic, to IEC60068-2-30				
Ambient temperature						
Open	°C	-25-55	-25-55	-25-55	-25-55	-25-55
Enclosed	°C	-25-40	-25-40	-25-40	-25-40	-25-40
Temperature compensation	°C	-5-40	-5-40	-5-40	-5-40	-5-40
Mounting position		→ 88	→ 88	→ 88	→ 88	→ 88
Weight	kg	0.15	0.15	0.25	1.64	1.64
Protection type		IP20	IP20	IP00	IP00	IP00

Main contacts

			XTOD..CC1	XTOD..DC1	XTOD..EC1	XTOD..FC1	XTOD..GC1
Rated impulse withstand voltage	U_{imp}	VAC	6000	6000	6000	6000	6000
Overvoltage category/pollution degree			III/3	III/3	III/3	III/3	III/3
Rated insulation voltage							
AC	U_i	VAC	690	690	690	690	690
Rated operational voltage	U_e	VAC	600	600	600	600	600
Overload release setting range		A	0.3-30	17-32	17-40	17-40	17-97
Terminal capacity							
Solid		mm ²	1 x (1-6) 2 x (1-6)	1 x (2.5-16) 2 x (2.5-16)	1 x (2.5-16) 2 x (2.5-16)	1 x (2.5-16) 2 x (2.5-16)	1 x (2.5-16) 2 x (2.5-16)
Flexible with ferrule		mm ²	1 x (1-6) 2 x (1-6)	1 x (1-6) 2 x (1-6)	1 x (1-6) 2 x (1-6)	1 x (1-6) 2 x (1-6)	1 x (1-6) 2 x (1-6)
Solid/stranded		AWG					
Terminal screw			M4	M5	M5	M5	M5
Tightening torque		Nm	1.2	2.5	2.5	2.5	2.5

Auxiliary and control circuits

			XTOD..CC1	XTOD..DC1	XTOD..EC1	XTOD..FC1	XTOD..GC1
Rated impulse withstand voltage	U_{imp}	V	6000	6000	6000	6000	6000
Overvoltage category/pollution degree			III/3	III/3	III/3	III/3	III/3
Terminal capacity							
Solid		mm ²	1 x (1-6) 2 x (1-6)	1 x (1-6) 2 x (1-6)	1 x (1-6) 2 x (1-6)	1 x (1-6) 2 x (1-6)	1 x (1-6) 2 x (1-6)
Flexible with ferrule		mm ²	1 x (1-6) 2 x (1-6)	1 x (1-6) 2 x (1-6)	1 x (1-6) 2 x (1-6)	1 x (1-6) 2 x (1-6)	1 x (1-6) 2 x (1-6)
Solid/stranded		AWG					
Terminal screw			M3.5	M3.5	M3.5	M3.5	M3.5
Tightening torque		Nm	0.8	0.8	0.8	0.8	0.8
Rated insulation voltage	U_i	VAC	690	690	690	690	690
Rated operational voltage	U_e	VAC	600	600	600	600	600
Conventional thermal current	I_{th}	A	10	10	10	10	10
Rated operational current							
AC-15							
120V	I_e	A	6	6	6	6	6
220/240V	I_e	A	3	3	3	3	3
380V	I_e	A	1.9	1.9	1.9	1.9	1.9
480V	I_e	A	1.5	1.5	1.5	1.5	1.5
500V	I_e	A	1.4	1.4	1.4	1.4	1.4
600V	I_e	A	1.2	1.2	1.2	1.2	1.2
DC-13							
125V	I_e	A	0.55	0.55	0.55	0.55	0.55
250V	I_e	A	0.27	0.27	0.27	0.27	0.27

Dimensions

Thermal overload relay

XTOD..CC1

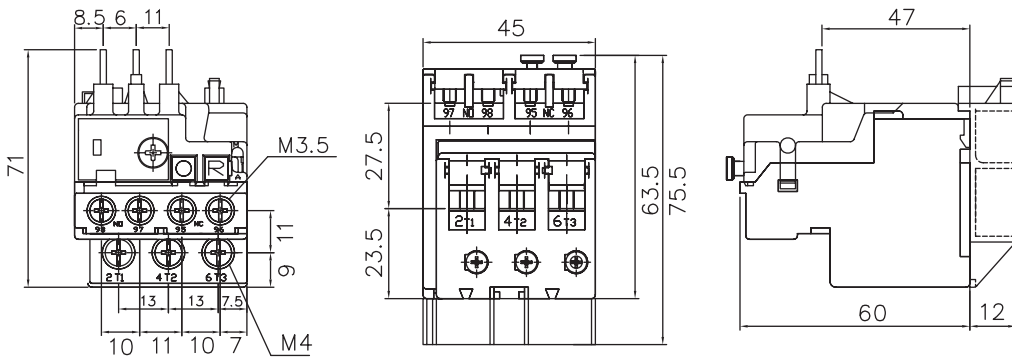

XTOD..DC1

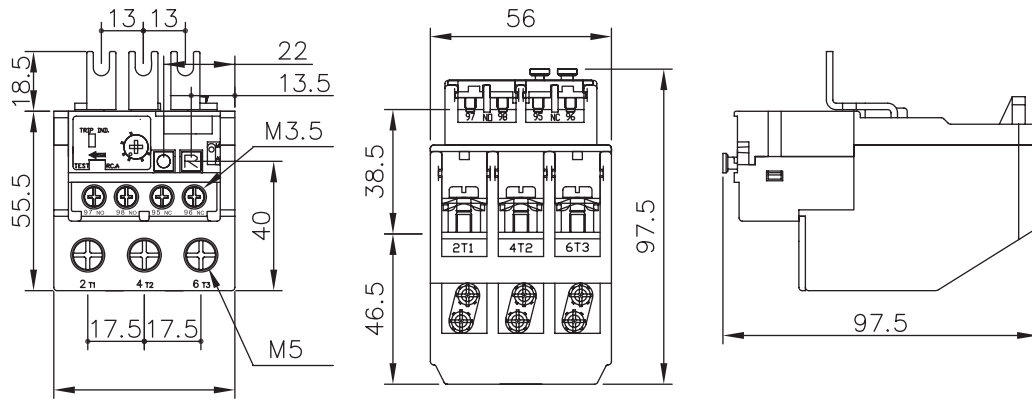

XTOD..EC1

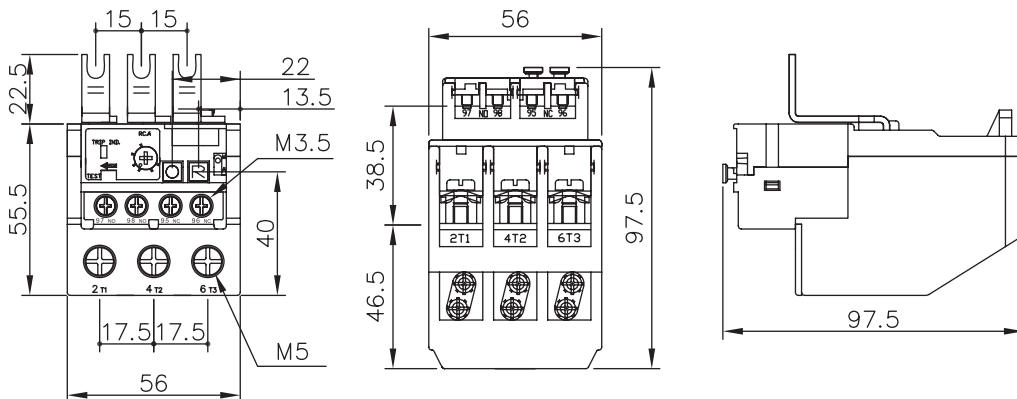

1.4 Thermal overload relays XTOD

Dimensions

1

Thermal overload relay

XTOD..FC1

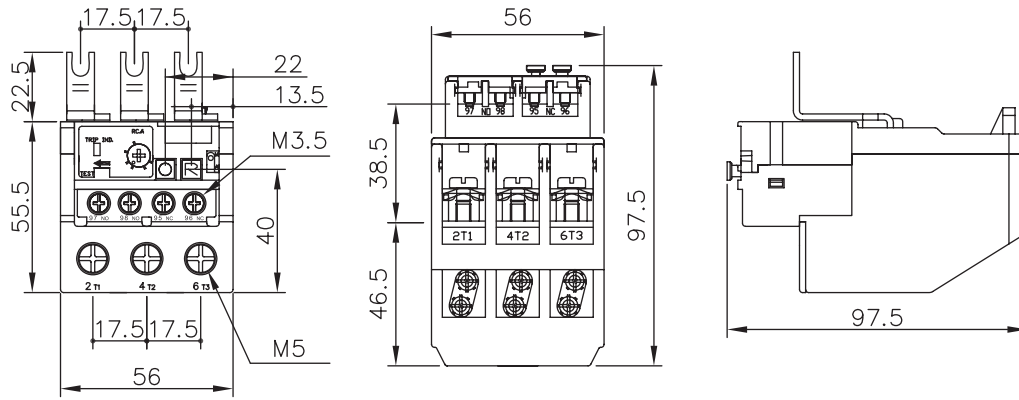

XTOD..GC1

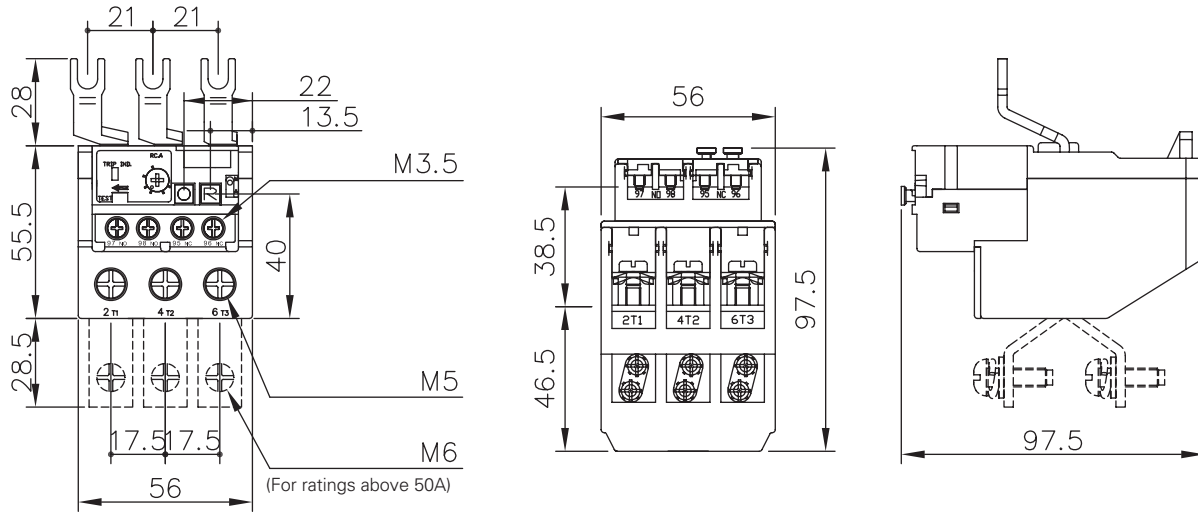

XTOD..GC1S

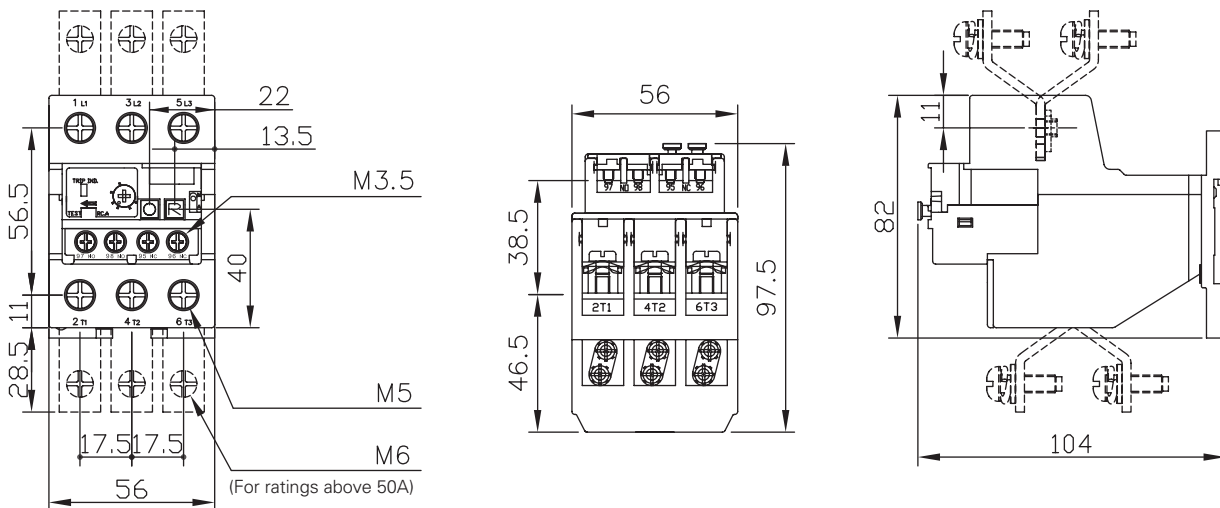

Thermal overload relay + mounting adapter

XTOD..CC1+XTODXDINC

1

